

Thank you for choosing

Panasonic
Professional/Industrial Video

VHS

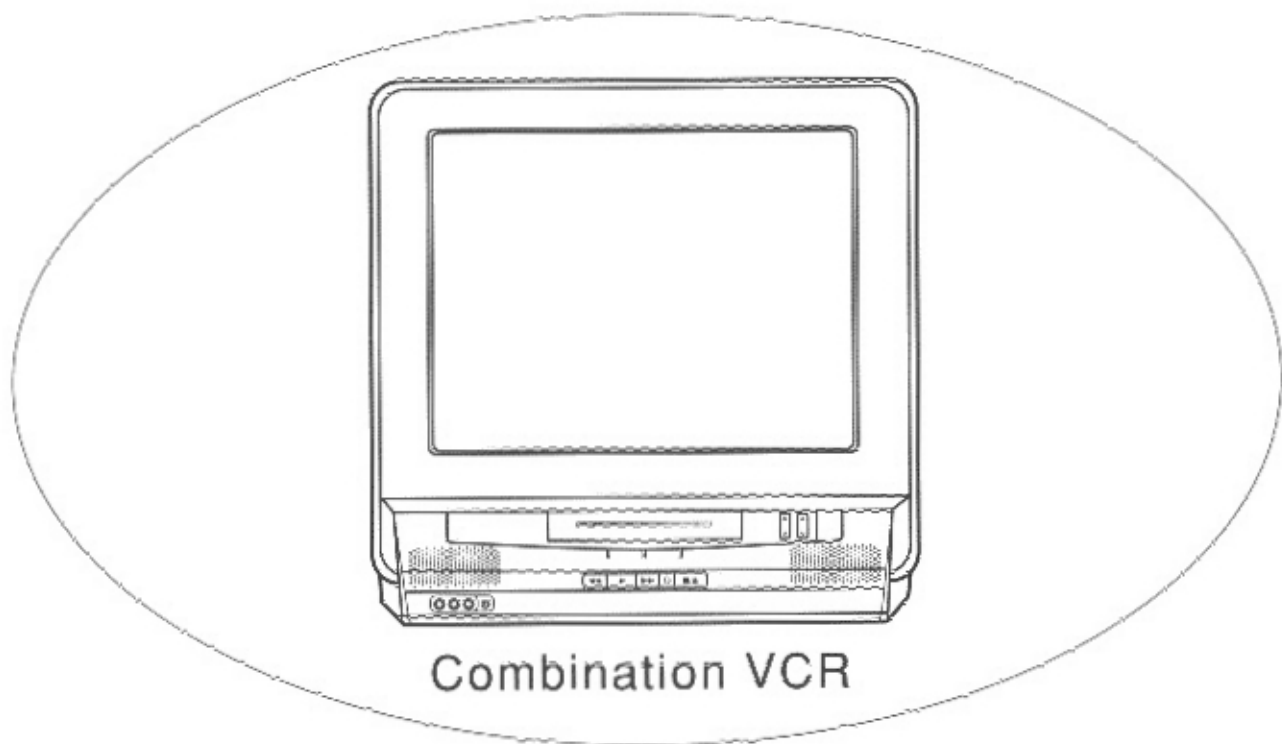

Combination VCR

MODEL AG-527C

**PRO
LINE**

Operating Instructions

Please read these instructions carefully before attempting to connect, operate or adjust this product. Please save this manual.

P2 ~ P11
Getting Started

P12 ~ P15
Basic TV Operation

P16 ~ P18
Basic VCR Operation

P19 ~ P25
More you Can Do

P26 ~ P27
Other Information

Things You Should Know

Congratulations

on your purchase of one of the most sophisticated and reliable products on the market today. Used properly, it will bring you and your family years of enjoyment. Please fill in the information at right. The serial number is on the tag located on the back of your Combination VCR.

Date of Purchase _____
Dealer Purchased From _____
Dealer Address _____
Dealer Phone No. _____
Model No. **AG-527C** _____
Serial No. _____

Safety Precautions

Warning: To prevent fire or shock hazard, do not expose this equipment to rain or moisture.

This video recorder, equipped with the HQ (High Quality) System, is compatible with existing VHS equipment. Only use those tapes with the **VHS** mark. It is recommended that only cassette tapes that have been tested and inspected for use in 2, 4, 6, and 8 hour VCR machines be used.

This television receiver provides display of television closed captioning in accordance with §15.119 of the FCC rules.



		This symbol warns the user that uninsulated voltage within the unit may have sufficient magnitude to cause electric shock. Therefore, it is dangerous to make any kind of contact with any inside part of this unit.
		This symbol alerts the user that important literature concerning the operation and maintenance of this unit has been included. Therefore, it should be read carefully in order to avoid any problems.

Table of Contents

Important Safeguards and Precautions.....	3
Unpacking Your Combination VCR • Product Features	4
Getting Started	
Antenna or Cable Connections (Outdoor Antenna, Cable Box, Scrambled/Unscrambled Channels)	5
Location of Controls (Remote Control, Combination VCR)	6, 7
One Time Setup (Tuner ON or OFF, On-Screen Language, Channel Memory, Auto Clock Set)	8, 9, 10
On-Screen Displays (OSD) (Function, Channel, Menu, VCR Status/Clock, Warning, Instruction)	11
Basic TV Operation	
TV Operation (Main Operation, Using the 100 key, Rapid Tune, Audio Mute, Phones)	12
Audio/Picture Adjustment (Bass, Treble, Color, Tint, Bright, Picture, Sharpness, Reset)	13
TV Timer Features (On Timer, Sleep Timer)	14
Closed Caption System (Main Operation, Caption On Mute).....	15
Basic VCR Operation	
Playback a Tape (Special Effects, Quality Picture Features)	16
Tape Operation (Play Lock, Repeat Play, One Minute Skip, Zero Search, Auto Functions)	17
Record On a Tape (Main Operation, One Touch Record, Input Select)	18
More You Can Do	
Copying Your Tapes (Connection, Main Operation)	19
Timer Playback (Main Operation, Cancel, Clear or Replace Program).....	20, 21
Timer Recording (Main Operation, Cancel, Clear or Replace Program).....	22, 23
MTS Broadcast/VHS Hi-Fi Stereo System (Stereo/SAP/Mono Broadcast, Select Audio Mode)	24, 25
Other Information	
Unit and Cassette Information	26
Before Requesting Service (Self-check Items)	27

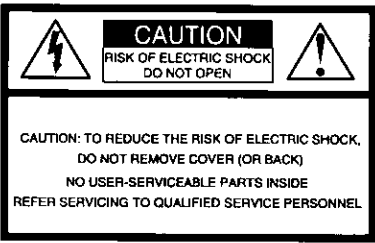

Important Safeguards and Precautions

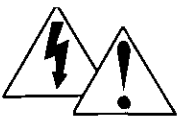
FOR YOUR SAFETY, READ AND RETAIN ALL SAFETY AND OPERATING INSTRUCTIONS. HEED ALL WARNINGS IN THE MANUAL AND ON THE UNIT

INSTALLATION

1 POWER SOURCE CAUTION

Operate only from a power source indicated on the unit or in this manual. If necessary, have your Electric Utility Service Company or Video Products Dealer verify the power source in your home.

2 POLARIZED OR GROUNDING PLUG

As a safety feature, this Video product comes with either a polarized power cord plug (one blade is wider than the other), or a three-wire grounding type plug.

POLARIZED PLUG CAUTION:

This plug will only fit into an outlet one way. If you cannot fully insert the plug, try reversing it. If it still will not fit, have an electrician install the proper wall outlet. Do not defeat the safety feature by tampering with the plug.

GROUNDING PLUG CAUTION:

This plug will only fit into a three-hole grounding outlet. If necessary, have an electrician install the proper outlet. Do not defeat the safety feature by tampering with the plug.

3 POWER CORD

Make sure power cords are routed so that they are not likely to have anything rest on them, roll over them, or be in the way of walking traffic.

If an extension cord is used, make sure it also has either a polarized or grounded plug and that the cords can be securely connected.

Frayed cords, damaged plugs, and damaged or cracked wire insulation are hazardous and should be replaced by a qualified service technician.

Overloaded outlets and extension cords are fire hazards and should be avoided.

4 DO NOT BLOCK VENTILATION HOLES

Ventilation openings in the cabinet release heat generated during operation. If they are blocked, heat build-up inside the unit can cause failures that may result in a fire hazard or heat damage to cassettes.

For protection follow these rules:

- Never cover ventilation slots or the unit while in use, or operate the unit when placed on a bed, sofa, rug, or other soft surface.
- Avoid built-in installation, such as a book case or rack, unless proper ventilation is provided.

5 AVOID EXTREMELY HOT LOCATIONS OR SUDDEN TEMPERATURE CHANGES

Do not place the unit over or near any kind of heater or regulator, in direct sunlight, inside a closed vehicle, etc.. Do not move the unit suddenly between areas of extreme temperature variation. If the unit is suddenly moved from a cold place to a warm place, moisture may condense in the unit and on the tape.

6 TO AVOID PERSONAL INJURY

- Do not place unsecured equipment on a sloping surface.
- Support for the unit should be firm, level, and adequately strong.
- An appliance and cart combination should be moved with care. Quick stops, excessive force, and uneven surfaces may cause the appliance and cart combination to overturn.
- Carefully follow all operating instructions and use the manufacturer's recommended accessories when operating this unit or connecting it to any other equipment.



OUTDOOR ANTENNA INSTALLATION

1 SAFE ANTENNA AND CABLE CONNECTION

If an outside antenna or cable system is connected to the equipment, be sure the antenna or cable system is grounded so as to provide some protection against built up static charges and voltage surges. Section 810 of the National Electrical Code, ANSI/NFPA 70 (in Canada, part 1 of the Canadian Electrical Code) provides

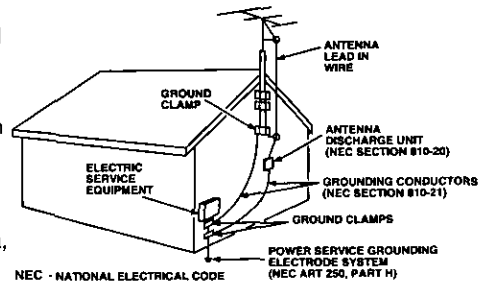

information with respect to proper grounding of the mast and supporting structure, grounding of the lead-in wire to an antenna discharge unit, size of grounding conductors, location of antenna discharge unit, connection to grounding electrodes and requirements for the grounding electrode.

2 KEEP ANTENNA CLEAR OF HIGH VOLTAGE POWER LINES OR CIRCUITS

An outside antenna system should be located well away from power lines, electric light or power circuits and where it will never come into contact with these power sources if it should happen to fall. When installing an outside antenna, extreme care should be taken to avoid touching power lines, circuits or other power sources as this could be fatal. Because of the hazards involved, antenna installation should be left to a professional.

USING THE VIDEO UNIT

If the unit has been in storage or moved to a new location, refer first to the INSTALLATION section of these safeguards.

1 KEEP THIS VIDEO UNIT AWAY FROM WATER OR MOISTURE OF ANY KIND.

2 IF EQUIPMENT IS EXPOSED TO RAIN, MOISTURE, OR STRONG IMPACT, unplug the unit and have it inspected by a qualified service technician before use.

3 DURING AN ELECTRICAL STORM

During a lightning storm, whether indoors or outdoors, or before leaving the unit unused for extended periods of time, disconnect all equipment from the power source as well as the antenna and cable system.

4 WHEN THE UNIT IS PLUGGED IN

- Never expose the unit to rain or water. DO NOT OPERATE if liquid has been spilled into the unit. Immediately unplug the unit, and have it inspected by a service technician. Fire and shock hazards can result from electrical shorts caused by liquid contact inside.
- Never drop or push any object through openings in the unit. Some internal parts carry hazardous voltages and contact can cause electric shock or fire hazard.
- Avoid placing the unit directly above or below your TV set as this may cause electrical interference. Keep all magnets away from electronic equipment.

5 USING ACCESSORIES

Use only accessories recommended by the manufacturer to avoid risk of fire, shock, or other hazards.

6 CLEANING THE UNIT

Unplug the unit. Then, use a clean, dry, chemically untreated cloth to gently remove dust or debris. DO NOT USE cleaning fluids, aerosols, or forced air that could over-spray, or seep into the unit and cause electrical shock. Any substance such as wax, adhesive tape, etc. may mar the cabinet surface. Exposure to greasy, humid, or dusty areas may adversely affect internal parts.

SERVICE

1 DO NOT SERVICE THIS PRODUCT YOURSELF

If, after carefully following the detailed operating instructions, this Video product does not operate properly, do not attempt to open or remove covers, or make any adjustments not described in the manual. Unplug the unit and contact a qualified service technician.

2 IF REPLACEMENT PARTS ARE REQUIRED

Make sure the service technician uses only parts specified by the manufacturer, or those having the same safety characteristics as the original parts. The use of unauthorized substitutes may result in fire, electric shock, or other hazards.

3 HAVE THE SERVICE TECHNICIAN PERFORM A SAFETY CHECK

After any service or repairs to the unit, request the service technician to conduct a thorough safety check as described in the manufacturer's service literature to insure that the video unit is in safe operating condition.

Unpacking Your Combination VCR • Product Features

Unpacking Your Combination VCR

The accessories shown below are provided to help you use or set up your Combination VCR.

Accessories

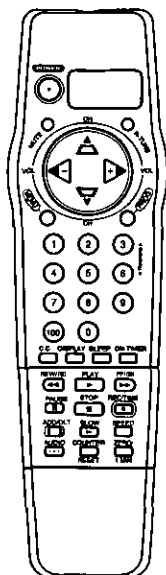

Remote Control
VSQS1512

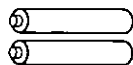

2 "AA" Batteries

Load the batteries

1 Push in and up on the latch with your thumb nail and lift off the lid.

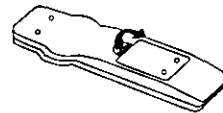

2 Install two batteries as indicated inside the Battery Compartment.

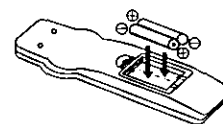

3 Fit the lid's hinge piece into the indent on the case, and snap the lid into place.

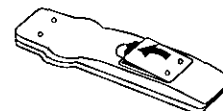

Battery replacement caution

- Do not mix old and new batteries.
- Do not mix alkaline with manganese batteries.

Product Features

All Channel Auto Set/181-CH TV/CATV Tuner	9
Auto Clock Set	9
Auto Daylight Saving Time	26
Auto Operation Functions (Auto Playback, Rewind, Tape Eject, Power Off)	17
Black Tube	16
Closed Caption System	15
Easy-to-Read English/Spanish/French On Screen Displays	8~10, 20~23
Front-mounted A/V In Terminals	19
MTS Broadcast System	24
One Minute Skip	17
One Month, 4 Program Auto Timer Playback.....	20, 21
One Month, 4 Program Auto Timer Recording	22, 23
One Touch Recording (OTR)	18
Quick Play Mechanism	27
Rapid Tune	11
Tuner ON/OFF System	8
Special Effects Playback	16
Unattended (Timer) Playback with Repeat Function	20, 21
VHS Hi-Fi Stereo System	24, 25
Zero Search	17



Antenna or Cable Connections

Outdoor Antenna Connection

Unhook the antenna from your previous TV or VCR and connect it to the back of the Combination VCR as shown in the diagram. If your antenna system has separate UHF and VHF lead-ins, you need a UHF/VHF Band Mixer (not supplied).

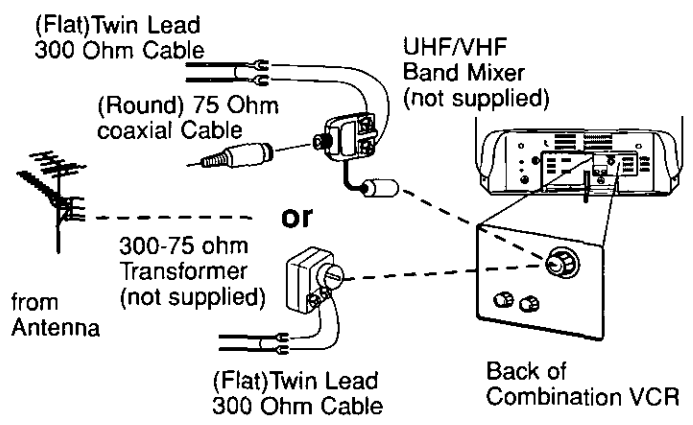

Cable Connections

(A) Without a Converter/Descrambler Box
With this connection, you can: use your Combination VCR remote control to select channels for viewing and select unscrambled channels for timer recording. Scrambled channels may not be viewed or recorded with this connection.

(B) With a Converter/Descrambler Box
With this connection, you may record and view any channel including scrambled channels. Please note, however that channel selection must be made at the cable company converter box. Timer recording is limited to one channel at a time, and you can only view the channel you are recording.

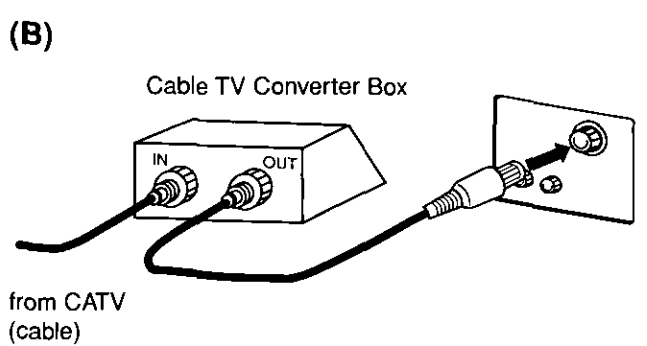
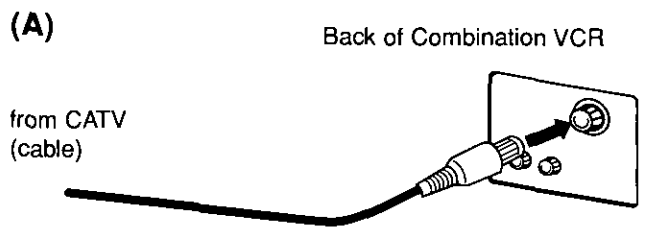

To Watch and Record Scrambled/Unscrambled Channels
Set the Combination VCR to the output channel of the cable converter box (e.g. CH3). Now, select channels to be viewed or recorded" at the cable converter box.

FCC WARNING: Any unauthorized changes or modifications to this equipment would void the user's authority to operate.

Note to CATV System Installer
This reminder is provided to call the CATV (Cable TV) System Installers attention to Article 820-40 of the NEC that provides guidelines for proper grounding and, in particular, specifies that the cable ground shall be connected to the grounding system of the building, as close to the point of cable entry as practical.



Location of Controls

Remote Control Buttons

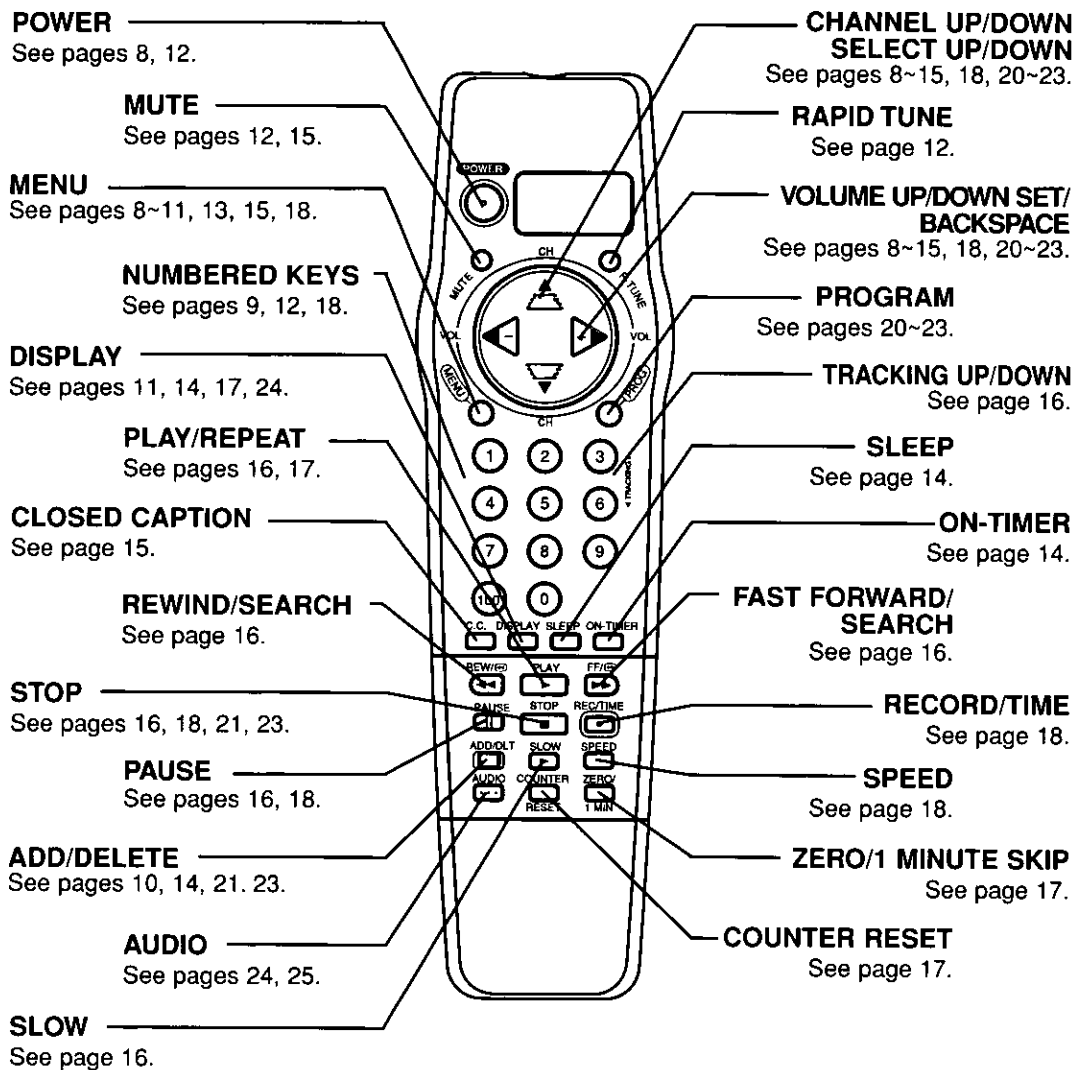

Indicators on the Front Panel

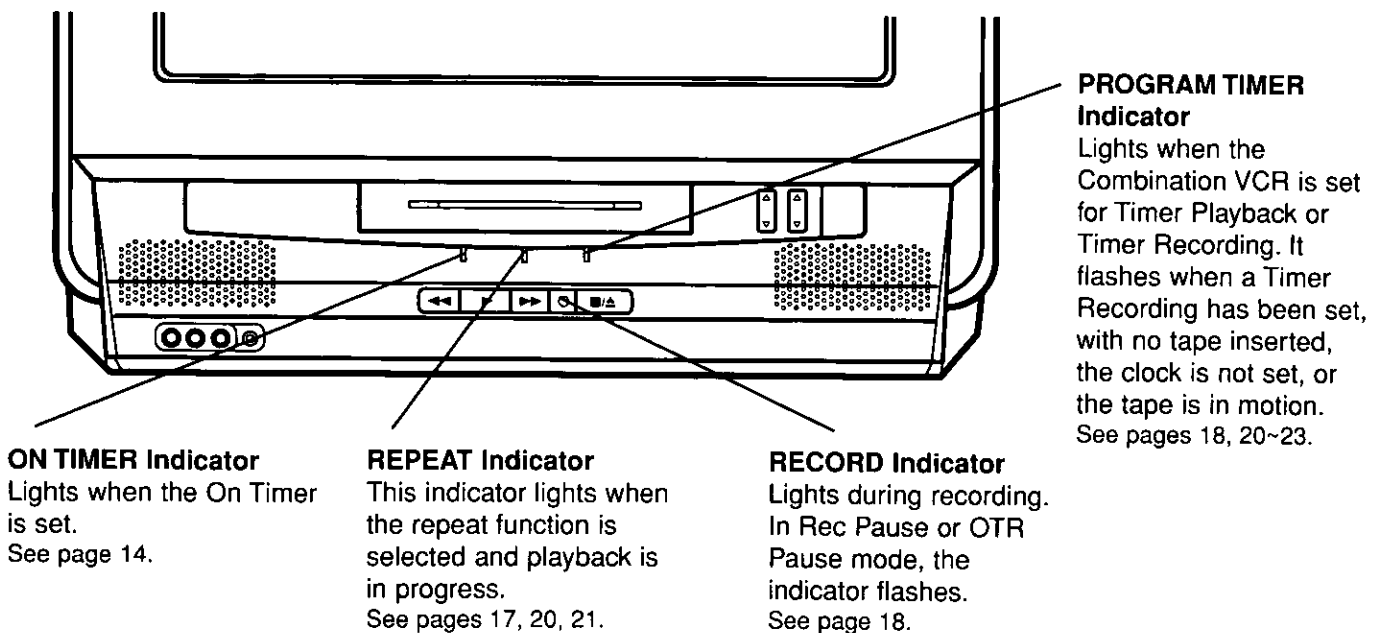

Front View of the Combination VCR

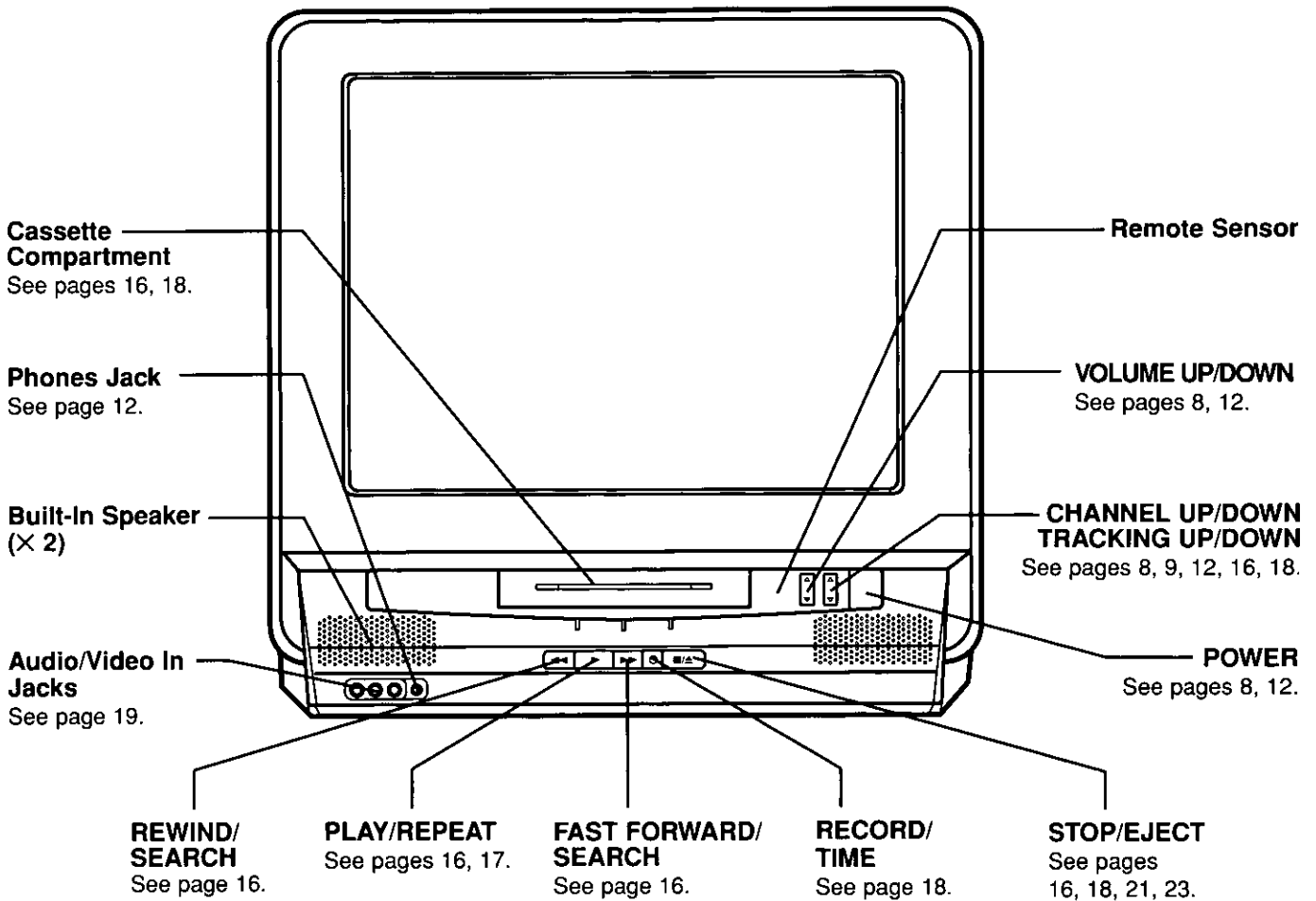

Rear View of the Combination VCR

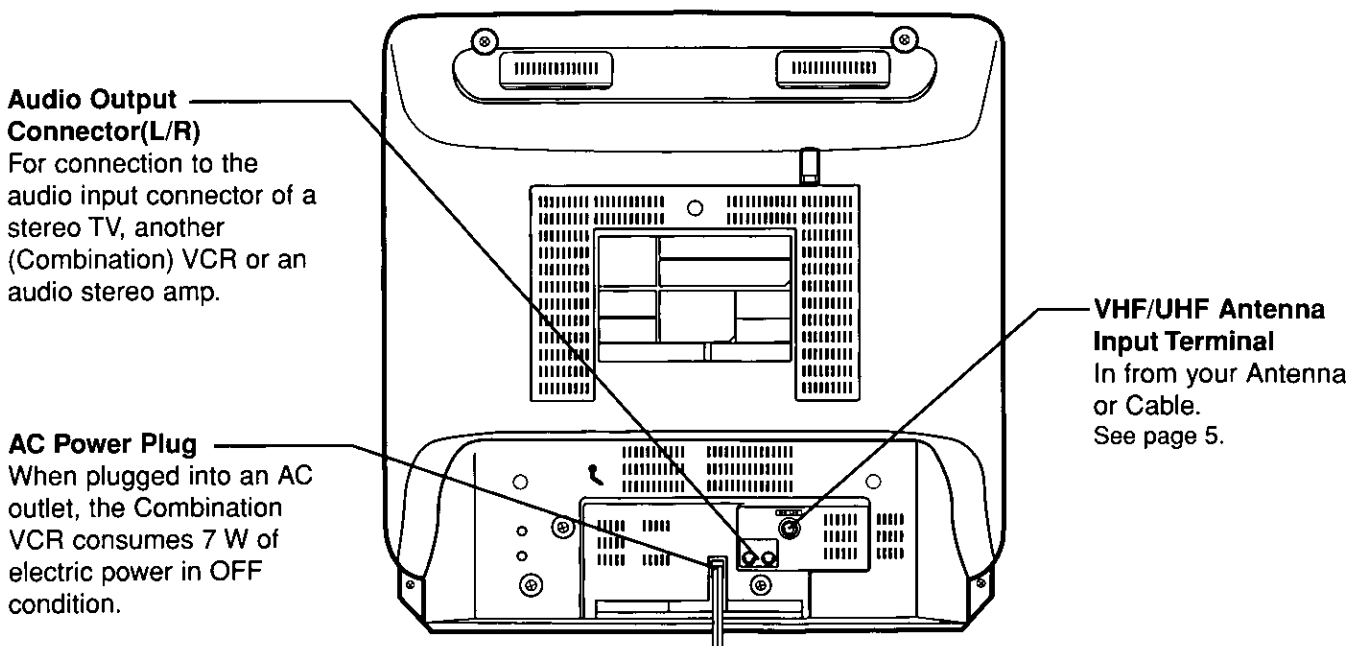



One Time Setup

Set the Clock (Initial Power On)

Your Combination VCR can be set to TUNER ON or TUNER OFF. When the Combination VCR is first turned on, the tuner is set to off and a prompt to set the clock is displayed. By selecting "TUNER:ON" (see below), you can place channels in memory and/or use the Auto/Clock Set feature (see next page).

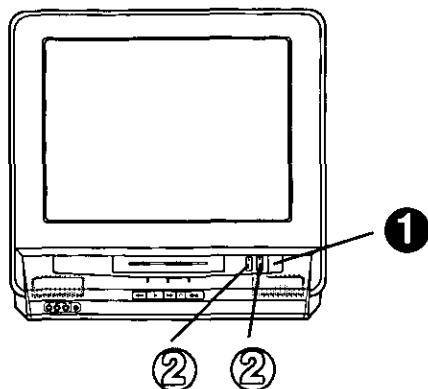

① Push **POWER** to turn the Combination VCR on.

② Push **▲**, **▼** or **▶** for on-screen displays in English, Spanish or French.

- If you choose the wrong language, please see the "Reset all Combination VCR Memory Functions" section on page 26.
- If you use a cable box, the cable box must be left on for auto channel set.

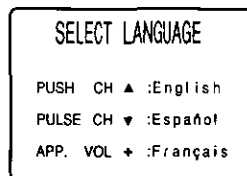

③ Push **▲** **▼** to select and **▶** to enter the month, date, year, time, and D.S.T. (Daylight Saving Time).

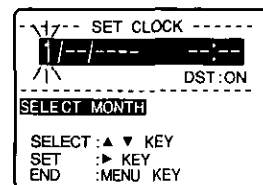

To Make Corrections,
push **◀▶** repeatedly to move back or forward to the desired item.

• "DST:ON" automatically adjusts for daylight saving time. (See page 26.)

④ Push **MENU** to start the clock. Then, push **▲** **▼** **◀▶** to select "EXIT." Now, push **MENU** to exit the MAIN MENU.

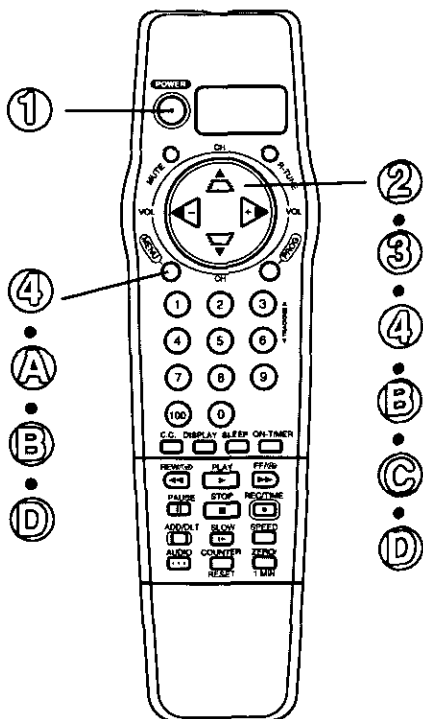

Select Tuner ON or OFF

When Tuner OFF is selected, your Combination VCR is automatically in LINE mode. When Tuner ON is selected, Channel selection, Input selection, Channel Add/Delete, etc. is available.

A Push **MENU** to display the MAIN MENU.

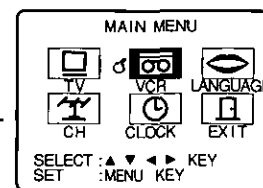

B Push **▲** **▼** **◀▶** to select "VCR," and then push **MENU** to display the SET UP VCR screen.

C push **▶** to select TUNER "ON" or "OFF."

- If you selected ON, go to the Set Up Channel and Auto Clock set selection at right.

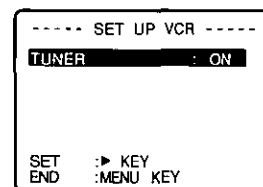

D Push **MENU** to end, and then push **▲** **▼** **◀▶** to select "EXIT." Now, push **MENU** to exit the MAIN MENU.

Using the keys

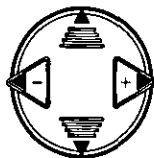

Whenever a menu or program screen is displayed, CHANNEL UP/DOWN and VOLUME UP/DOWN on the remote control function as **▲** **▼** **◀▶** only. For VOLUME UP/DOWN functions, use the buttons on the Combination VCR.

Check list before you begin.

- Your Combination VCR is connected to an Antenna, or Cable system (see page 5).

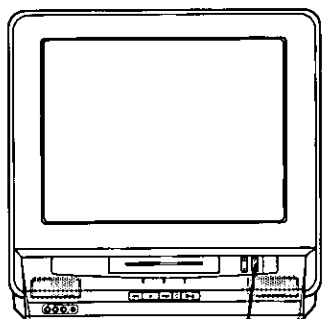

① • ②

Set up Channel and Auto Clock Set (TUNER:ON only)

- ① **Important: If you use a cable box, turn it on and select PBS station in your time zone.**



or



Push \blacktriangle or \blacktriangledown to display Channel Auto Set screen.

- ②  Push \blacktriangle to start Channel Auto Set.

These on-screen displays will appear in sequence.

- CH AUTO SET PROCEEDING
- CH AUTO SET COMPLETED

CHANNEL/CLOCK AUTO SET

CONNECT ANTENNA CABLE AND IF YOU USE A CABLE BOX, TUNE IT TO YOUR LOCAL PBS CH THEN...

PLEASE PUSH CH UP KEY

To Use the Auto Clock Set Feature

When "AUTO SET" is selected in the steps below, the CHANNEL/CLOCK AUTO SET screen appears. If Channel Auto Set has already been completed in the above steps, only Auto Clock Set will be performed.

- 1 Push MENU to display the MAIN MENU.
- 2 Push \blacktriangle \blacktriangledown \blacktriangleleft \blacktriangleright to select "CLOCK." Then, push MENU to display the SET CLOCK screen.
- 3 Push \blacktriangle \blacktriangledown to select "AUTO SET," and then \blacktriangleright to start Channel Auto Set and Clock Auto Set.

These on-screen displays will appear in sequence.

- CH AUTO SET PROCEEDING
- CH AUTO SET COMPLETED
- AUTO CLOCK SET PROCEEDING

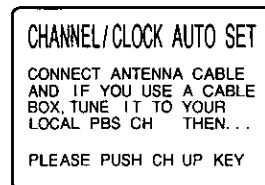
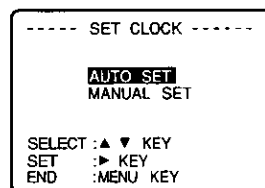

If AUTO CLOCK SET IS INCOMPLETE appears, please set the clock manually.

- a. Push MENU to display the SET CLOCK screen.
- b. Do steps 3 and 4 on previous page.



- Auto clock set will be performed when the Combination VCR is turned off the first time each day. If you use a cable box and you want auto clock set to be performed, the cable box must be left on and tuned to the PBS channel at the time the Combination VCR power is turned off.
- If for any reason the time is changed manually, automatic time correction will not occur.

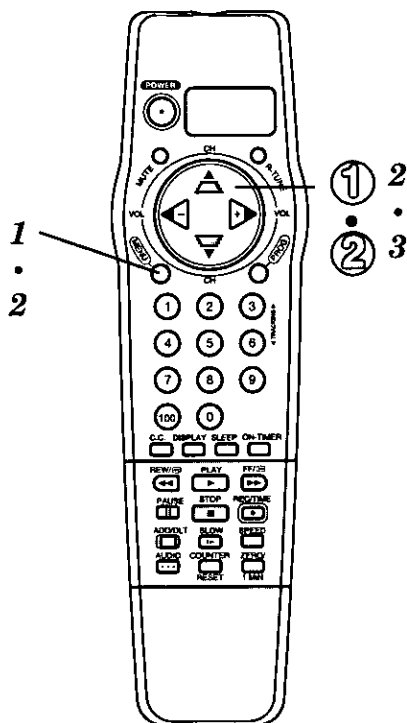

① 2
② 3
③ 4

1 • 2



One Time Setup (Continued)

To Change or Re-enter One Time Setup Items

To Change the OSD Language

- 1 Push MENU to display the MAIN MENU.
- 2 Push $\Delta \nabla \triangleleft \triangleright$ to select the language selection icon.
- 3 Push MENU repeatedly to change the language as shown.

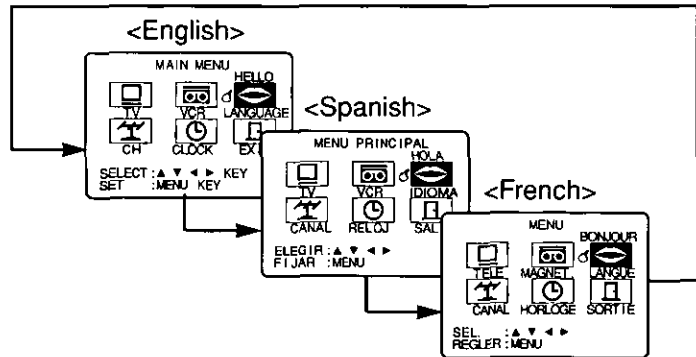

- 4 Push $\Delta \nabla \triangleleft \triangleright$ to select "EXIT," and then push MENU to exit the MAIN MENU.

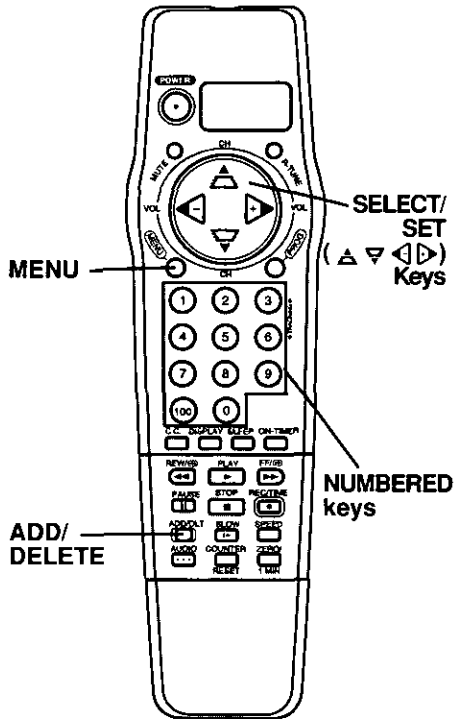

To Replace Channels in Memory (TUNER:ON only)

In case, you have cable installed, etc.

- 1 Push MENU to display the MAIN MENU.
- 2 Push $\Delta \nabla \triangleleft \triangleright$ to select "CH," and then push MENU to display the SET UP CHANNEL screen.
- 3 Push $\Delta \nabla$ repeatedly to select ANTENNA SYSTEM, and then push \triangleright to select your antenna system (TV or CATV).
- 4 Push $\Delta \nabla$ to select AUTO SET, and then push to start.
 - To exit this mode, push MENU. Then, push $\Delta \nabla \triangleleft \triangleright$ to select "EXIT." Now, push MENU to exit the MAIN MENU.

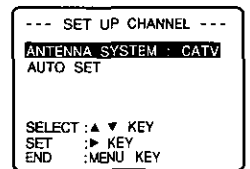
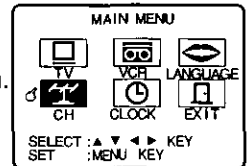

To Add or Delete a Channel (TUNER:ON only)

- 1 Select a channel using the NUMBERED keys to add or the CH $\Delta \nabla$ to delete.
- 2 Push the ADD/DLT to add or delete the channel.
 - To select a channel once it's deleted, use the NUMBERED keys.

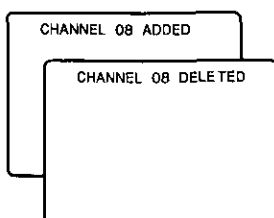

To Set or Reset the Clock

In case the clock is wrong, or a power failure occurred.

- 1 Push MENU to display the MAIN MENU.
 - 2 Push $\Delta \nabla \triangleleft \triangleright$ to select "CLOCK." Then, push MENU to display the SET CLOCK screen.
- (Only when TUNER:ON is selected)**
- 3 Push $\Delta \nabla$ to select "MANUAL SET," and then \triangleright to display the SET CLOCK screen.
 - 4 Please do steps 3 and 4 on page 8.

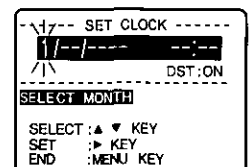
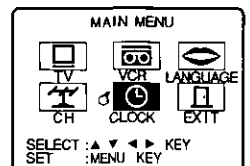

- This Combination VCR will accurately maintain its calendar up to Dec. 31, 2089, 11:59PM.
- Normal TV or Cable channels are automatically selected and placed in memory depending on how your Combination VCR is hooked up.



On Screen Displays (OSD)

Channel & Function Display

Whenever the channel is changed, the channel number will appear for a few seconds on-screen. (Some station names may also appear.)

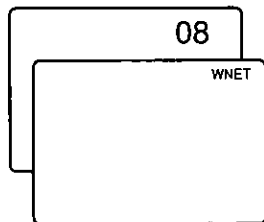

When a function button is pushed (PLAY, FF, etc.), the Combination VCR mode will be displayed.

- When a recording is started, both REC and the channel number will appear together.

Warning and Instruction Displays

These displays will alert you of a missed operation or provide further instructions.

If no active channels are found for CHANNEL MEMORY... (see page 5.)

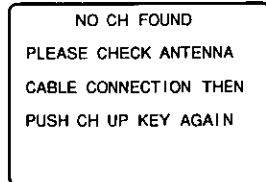

If you attempt to set or review a Timer Playback, Timer Recording or set the On Timer and the Clock is not set... (see pages 8~10.)

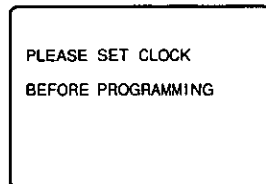

Menu Screen

- 1 Push MENU to display the MAIN MENU.
- 2 Push Δ ∇ \leftarrow \rightarrow and MENU to make your selection (see page 8).

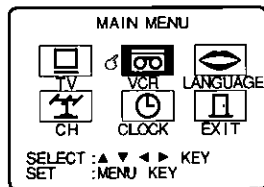

- To get the most from each feature, please read the Operation Manual before attempting any operation.

If you push REC on the remote control or the Combination VCR, and a cassette is inserted with no record tab... (see page 26.)

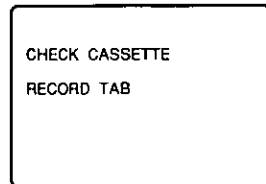

VCR Status & Clock Display

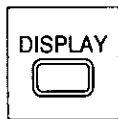

Push DISPLAY to display and remove the overlay shown below.

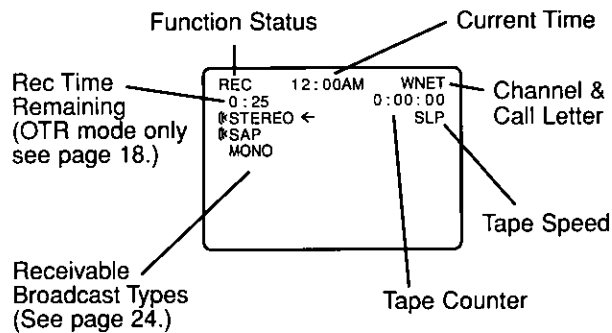

If you push STOP during a Timer Playback or Timer Recording... (see pages 21, 23.)

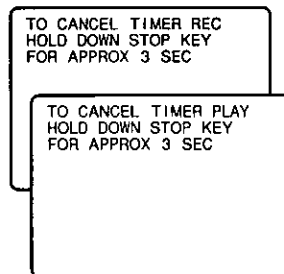

If you push PLAY, FF, REW, or REC on the remote control or the Combination VCR without a cassette inserted... (see pages 16~18.)

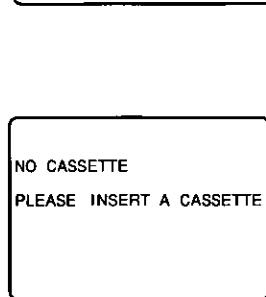

Blank Tape/ No Video Signal Indication

When a blank section of tape comes up in Play mode, or the selected channel has no broadcast signal, the TV screen will turn solid blue.

If Combination VCR is not in Stop mode or a cassette with record tab is not inserted two minutes before a Timer Playback or Timer Recording is about to begin... (see pages 20~23.)

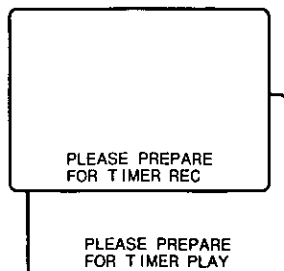



TV Operation

✓ Check list before you begin.

- All connections are made (see page 5).
- Your Combination VCR is plugged in.

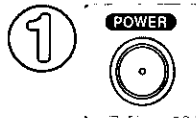

Push **POWER** to turn the Combination VCR on.

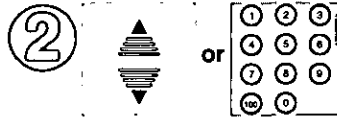

Select a channel using Δ ∇ or the **NUMBERED** keys.



Push **VOL** \triangleleft \triangleright to adjust the volume level.

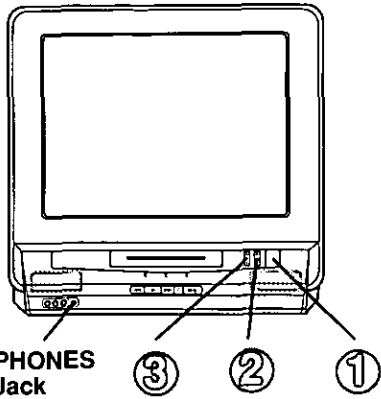
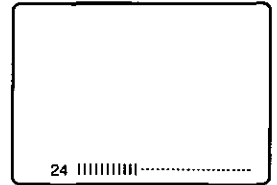

PHONES Jack

Using the 100 key (TUNER:ON only)

When selecting CATV channels 100 to 125 with the **NUMBERED** keys, first push the 100 key, and then enter the remaining two digits. For example, for channel 125: Push the **NUMBERED** keys 100-2-5.

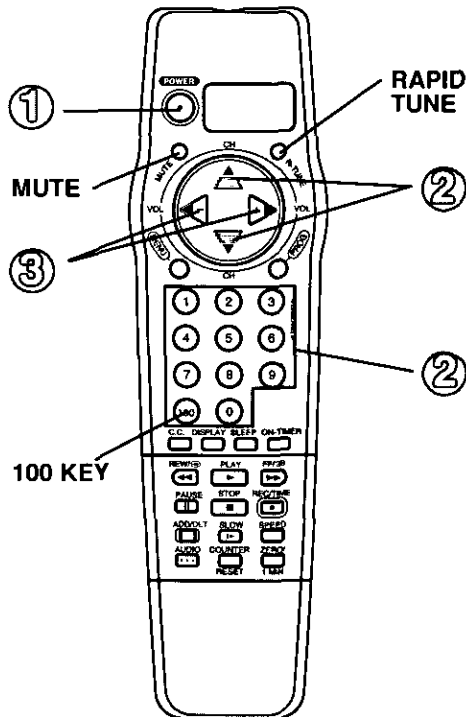

RAPID TUNE

MUTE

100 KEY

Rapid Tune (TUNER:ON only)

Push **R-TUNE** to display the last channel you were watching.

- When selecting channels with **CH** Δ ∇ , the channels must be displayed for at least 4 seconds in order for the Combination VCR to recognize them as a new selection.

Previous channel Present channel

CH08 \longleftrightarrow **CH10**

Audio Mute

Push **MUTE** to instantly mute the sound. Push again, to restore the previous sound level.

Phones

Connect an earphone (not supplied) or headphone (not supplied) to the Phones Jack.

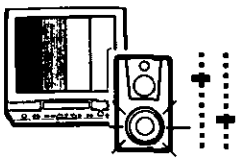

Audio/Picture Adjustment

✓ Check list before you begin.

- All connections are made (see page 5).
- Your Combination VCR is plugged in.

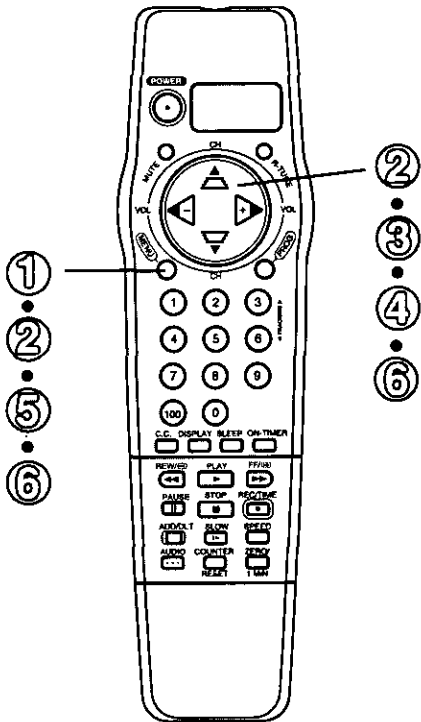

① Push MENU to display the MAIN MENU.

The TUNER:ON main menu is shown

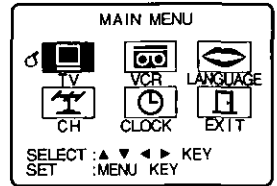

② Push ▲ ▼ ◀ ▶ to select "TV," and then push MENU to display the SET UP TV screen.

③ Push ▲ ▼ to select "AUDIO ADJUST" or "VIDEO ADJUST," and then push ▶ to display the AUDIO ADJUST or VIDEO ADJUST screen.

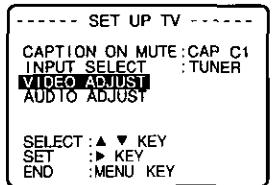
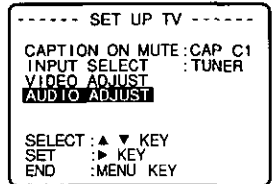

• The Input Select item in the SET UP TV menu only appears when TUNER:ON is selected (page 8).

④ Push ▲ ▼ repeatedly to select the desired adjust item, and then push ◀ ▶ to adjust. (See description at left.)

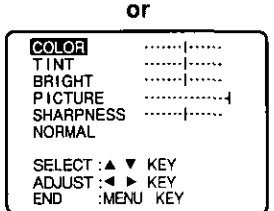
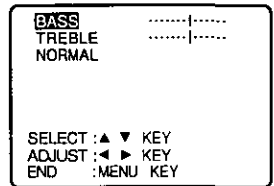

Audio Adjustment

BASS Control

To adjust the intensity of low frequency sound.

TREBLE Control

To adjust the intensity of high frequency sound.

- The levels set here do not affect other audio equipment when connected to the Audio Output L/R Connector.

Picture Adjustment

COLOR Control

To adjust the intensity of the colors.

TINT Control

To adjust for the most natural fleshtones.

BRIGHT Control

To adjust the brightness of the picture.

PICTURE Control

To adjust the intensity of the picture by adjusting contrast and color level at the same time and in the proper balance.

SHARPNESS Control

To adjust the sharpness of the picture.

To Reset Audio/Picture Controls to the Factory Setting

Push ▲ ▼ and ▶ to select and set NORMAL.

All controls return to factory settings.

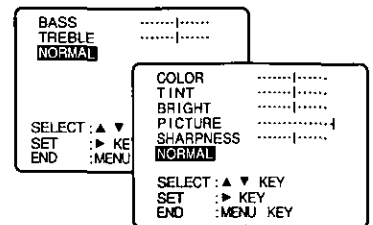

⑤ Push MENU twice to exit the VIDEO ADJUST mode.

- If no button is pushed within 5 minutes, the audio or video adjust overlay disappears.

⑥ Push ▲ ▼ ◀ ▶ to select "EXIT," and then push MENU to exit the MAIN MENU.

Basic TV Operation

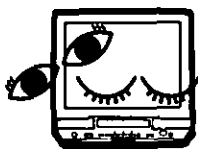

TV Timer Features

✓ Check list before you begin.

- All connections are made (see page 5).
- Your Combination VCR is plugged in.

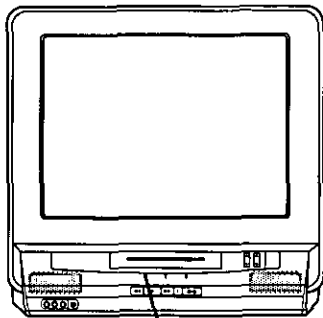

ON-TIMER Indicator

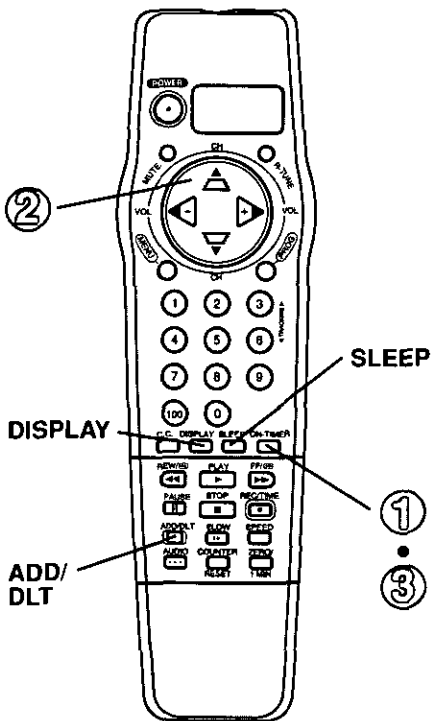

On Timer Feature

The Combination VCR can be set for auto power on. Even if you set the On timer, it will not be performed during Timer Play or Play Lock mode.

- ①  Push ON-TIMER to display the ON-TIMER screen.

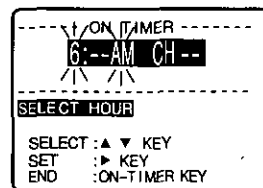

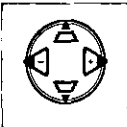
- ②  Push Δ ∇ to select and \blacktriangleright to fix the On Timer time and then to choose the On Timer mode (TV or PLAY).

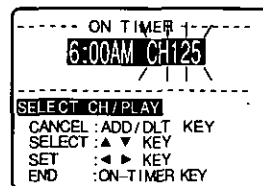

- You can choose TV or PLAY for the On Timer mode only when TUNER:ON is selected (page 8).
- Make sure a tape is inserted if VCR Playback mode is selected.

To Make Corrections,

use Δ ∇ and \blacktriangleleft \blacktriangleright to move back and correct as necessary.

- ③  Push ON-TIMER to set the On Timer. This screen will appear for about 5 seconds.

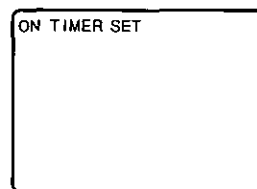

- The ON-TIMER indicator lights on the front panel.

To Cancel,

push ON-TIMER to redisplay the screen in step 2. Then, push ADD/ DLT to clear the time ("6" is flashing). Now, push ON-Timer to end. "ON-TIMER END" appears on-screen for a few seconds.



If no button on the remote or Combination VCR is pushed within 60 minutes after the Combination VCR turns itself on, it will turn itself back off.

Set the Sleep Timer

The Combination VCR can be set for auto power off.

-  Push SLEEP to display the desired sleep timer.

- Each push of SLEEP will change the time in the order shown at right.

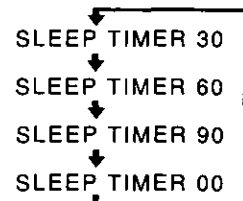

- If you push DISPLAY with the SLEEP TIMER set, the remaining time will appear on-screen.
- Sleep Timer will not be performed during Timer Play or Play Lock mode.

To Cancel, push SLEEP repeatedly until "SLEEP TIMER 00" appears.

CC Closed Caption System

This multi-use system not only allows the hearing impaired to enjoy selected programs, but also makes useful information from TV stations available to everyone.

✓ Check list before you begin.

- All connections are made (see page 5).
- Your Combination VCR is plugged in.

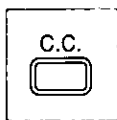
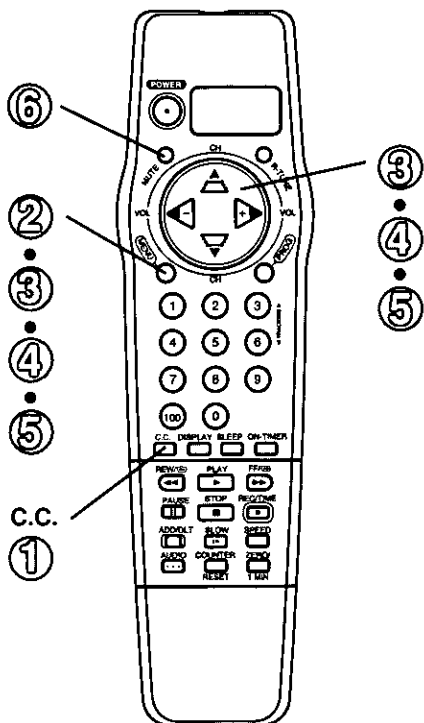

Push C.C. repeatedly to select the desired Caption Mode (see "Caption Mode description" below).

- Selected mode is displayed on screen.
- Each push of C.C. will change the Caption Mode as shown at right:

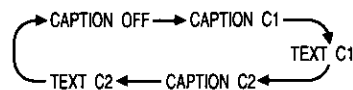

Closed Caption Modes to Choose From

Caption Mode: CAPTION C1 or C2

A narration of selected TV programs will be displayed on the screen. Check your TV program listings for C.C. (Closed Captioned) broadcasts.

Caption Mode: TEXT C1 or C2

The lower half of the screen will be blocked out. When the TV station broadcasts text, such as program listings, special information, etc., it will appear in this space.

Caption Mode: OFF

Narration will not appear on the screen even if a closed caption or text broadcast is received.

- The closed caption or text signal may be broadcast over C1, C2, or both. Also, text contents can vary so you may wish to try different settings.

Caption On Mute Feature

This feature allows you to turn off the sound and, at the same time, display Closed Caption narration. Perfect for when you need silence, but would like to continue enjoying the program.

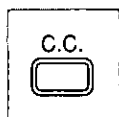

Push C.C. until CAPTION OFF is displayed on screen.

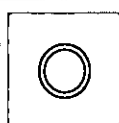
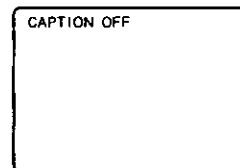

Push MENU to display the MAIN MENU.

The TUNER:ON main menu is shown.

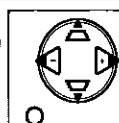

Push Δ ∇ \leftarrow \rightarrow to select "TV," and then push MENU to display the SET UP TV screen.

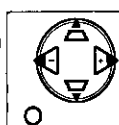
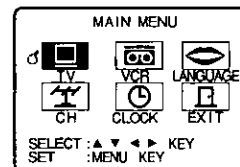

Push \rightarrow repeatedly to select the desired caption on mute mode, and then push MENU to exit the SET UP TV screen.

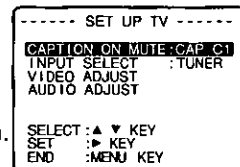

- The Input Select item in the SET UP TV menu only appears when TUNER:ON is selected (page 8).
- Each push of \rightarrow will change the display as shown at right.

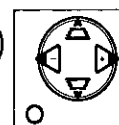
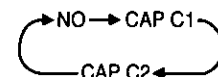

Push Δ ∇ \leftarrow \rightarrow to select "EXIT," and then push MENU to exit the MAIN MENU.

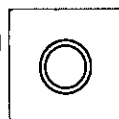

Push MUTE to instantly mute the sound. The closed caption narration is displayed on the screen.

- Push MUTE again to resume normal sound and picture.
- Not all programs have Closed Caption information, therefore, narration may not be displayed.

Recording and Playing Back a Closed Caption/Text Program

Record: Your Combination VCR will automatically record the Closed Caption/Text signal. Just follow normal recording operation.

Playback: To display the Closed Caption narration or Text during playback, simply push C.C. until desired Caption Mode is displayed.

▶ Playback a Tape

✓ Check list before you begin.

- All connections are made (see page 5).
- Your Combination VCR is plugged in.

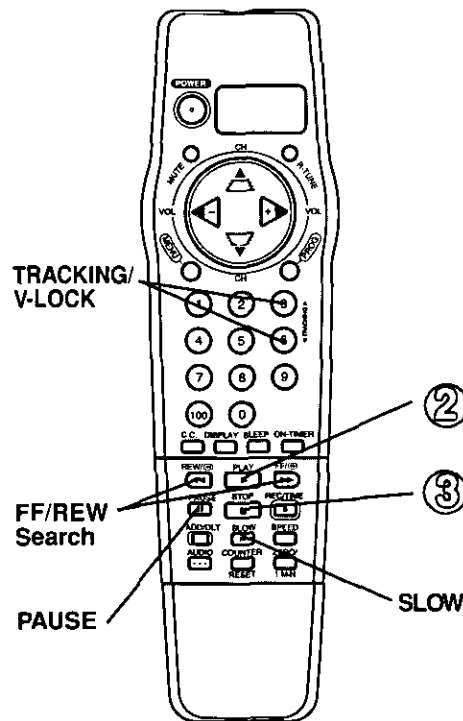
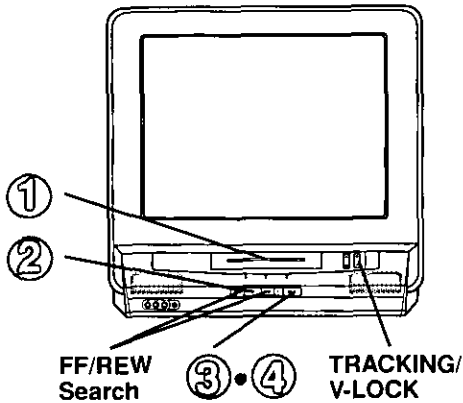

Caution:
Please inspect your cassette tapes and remove any loose or peeling labels to prevent them from becoming jammed in your unit.

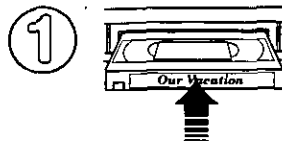
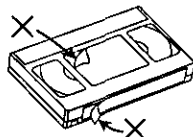

1 Insert a cassette.

- Combination VCR power comes on automatically.



2 Push **PLAY** on the remote control or Combination VCR to start playback.

- Playback begins automatically if cassette has no record tab (see page 17).

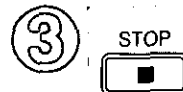

3 Push **STOP** on the remote control or Combination VCR to stop playback.

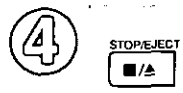

4 Push **STOP/EJECT** on the Combination VCR to eject the cassette.

- You may eject a cassette with power on or off.

To Find a Particular Scene During Playback

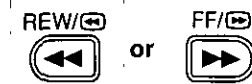

Push **REW** or **FF** on the remote control or Combination VCR to quickly locate a scene.

- SP mode tapes have a search speed of 9 times and SLP mode 27 times the normal speed.
- Some noise bars will appear during search.

Special Effects During Playback

These features work best in SP or SLP mode. The sound will be muted.

Slow Motion Playback

Push **SLOW** to start slow motion playback. Push **PLAY** or **SLOW** to release.

Still (Freeze) Frame Picture

Push **PAUSE** to freeze and release the picture.

- To reduce picture noise, first push **SLOW**. Then, use the 3 or 6 **NUMBERED** keys on the remote control or **CH UP/DOWN** on the Combination VCR to clear up the picture, then push **PAUSE**.

Frame by Frame Advance

While in Still mode, push **SLOW** repeatedly or hold down to advance the still picture one frame at a time. Push **PAUSE** or **PLAY** to release.

(After the Combination VCR is in Still or Slow mode for 3 minutes, it will switch to the Stop mode automatically to protect the tape and the video head.)

Features for a Quality Picture

Digital Auto Tracking

This feature continuously analyzes the signal and adjusts for optimum picture quality.

Manual Tracking Control

Use during Playback and Slow Motion mode to reduce picture noise.

Push the 3 or 6 **NUMBERED** keys on the remote control or **CH UP/DOWN** on the Combination VCR until the picture clears up.

To return to Auto Tracking, push **POWER** off and then on again.

V-Lock Control

In Still mode the 3 or 6 **NUMBERED** keys on the remote control or **CH UP/DOWN** on the Combination VCR operate as a V-Lock control to reduce jitter. Push one of these keys until the picture is stabilized.

Black Tube

This Combination VCR uses a Black tube for better color reproduction and picture contrast.



Tape Operation

Your Combination VCR is equipped with several time saving features as well as convenient automatic functions which make tape operation easier than ever.

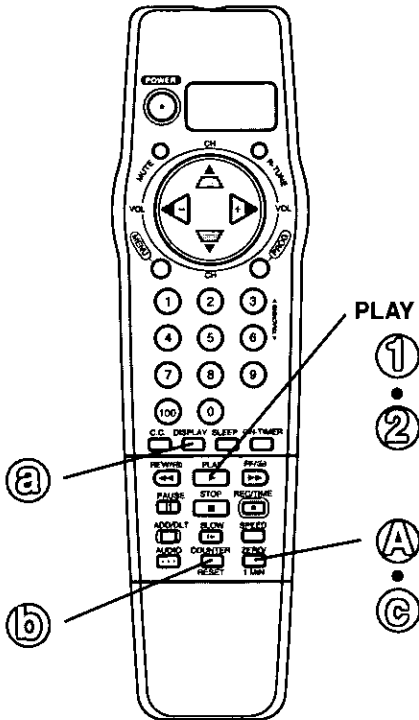

Auto Play with Repeat Function

From Playback mode you can set the Combination VCR to play your recording over and over.



Push **PLAY** on the remote control or Combination VCR during playback. The **REPEAT** indicator lights.

- When Repeat Play is turned on, the Combination VCR will play to the end of a tape, or until it reaches a blank portion 3 seconds or more. Then, the Combination VCR will automatically rewind the tape and play it again and again until you cancel repeat play.

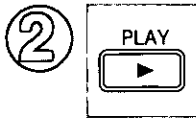

Push **PLAY** once again to turn the repeat function off. The **REPEAT** indicator goes out.

- All function buttons (REW, FF, etc.) are operational during Repeat Play.
- When the **REPEAT** indicator is lit, and a cassette with no record tab is inserted, the Combination VCR will automatically go into Repeat Play mode.

Play Lock Mode

The Combination VCR may be locked in Repeat Play mode so that all other function keys are inoperative.



Hold down **PLAY** on the remote control or Combination VCR for 7 seconds.

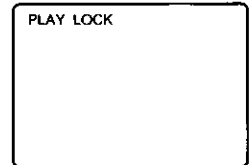

When the **Play Lock** mode is selected,

- the Auto Repeat function is activated automatically.
- the On Timer and Sleep Timer become nonfunctional.

To Cancel the VCR Lock Mode,

Hold down **PLAY** on the remote control or Combination VCR for 7 seconds again.

Auto Operation Functions

Auto Playback

When a tape is inserted, the power turns on (Auto). If the record tab* is removed, playback begins (Auto).

Auto Rewind

When a tape reaches its end during playback or fast forward the Combination VCR will rewind and go into Stop mode.

Playback Auto Eject (Repeat Play is off.)

When a tape without a record tab* is played to its end, the Combination VCR will rewind and then eject the tape.

Rec Auto Eject

After a tape reaches its end during normal recording, the Combination VCR will rewind and then eject the tape.

Memory Rewind Off

When **POWER** is pushed during rewind, rewind will be completed even though the Combination VCR turns off.

* For record tab information, see page 26.

One Minute Skip

With this feature, you can skip over commercials recorded on a tape.



Push **ZERO/1MIN** in Play mode.

- The Combination VCR will go into FF search mode and skip over 60 seconds of recorded time. Then, normal playback will resume.

Zero Search

You can reset the Timer Counter to zero and then return to that point.

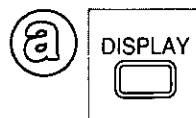

Push **DISPLAY** to display the Time Counter overlay.

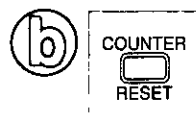
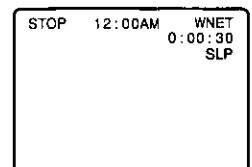

Push **COUNTER RESET** to reset the Time Counter.

- Reset to 0:00:00 at whatever point you wish on the tape.

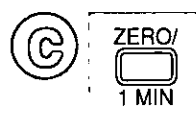
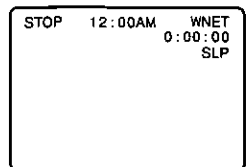

Push **ZERO/1MIN** in Stop mode.

- The Combination VCR will go into FF or REW mode and stop at the last point the Time Counter was set to 0:00:00.

Record On a Tape

Check list before you begin.

- All connections are made (see page 5).
- Your Combination VCR is plugged in.

- ① Insert a cassette with record tab.
- The Combination VCR power comes on automatically.

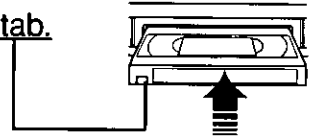

- ② Push Δ ∇ or NUMBERED keys on the remote control to select a channel.
- Or, push CH UP/DOWN on the Combination VCR.
 - To record from an outside source, push Δ ∇ to select LINE (see below).

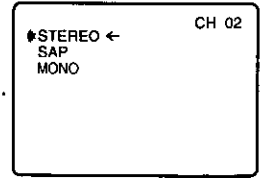

- ③ Push SPEED until the desired speed appears on-screen (See page 26).
- SP = Standard Play
LP = Long Play
SLP = Super Long Play

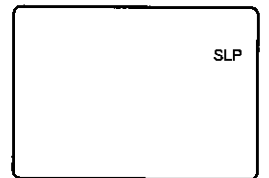

- ④ Push REC/TIME on the remote control to start recording.
- Or, push REC/TIME on the Combination VCR.
 - To edit out unwanted portions, push PAUSE to pause the recording in progress. To release, push PAUSE again.

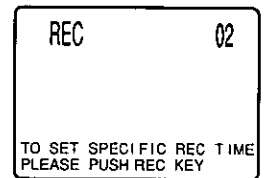

One Touch Timer Recording (OTR)

The Combination VCR stops recording at a preset time.

In step 4, push REC/TIME repeatedly to set the length of the recording. Each push will change the time as shown.

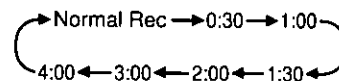

- PROGRAM TIMER indicator lights on the front panel.

- ⑤ Push STOP on the remote control to stop recording.
- Or, push STOP/EJECT on the Combination VCR.

NOTES

- While it is possible to change the tape speed when you are recording, there will be some distortion on the tape where the change occurred.
- The remaining recording time can be displayed by pushing DISPLAY in OTR mode.
- After the Combination VCR has been in Rec Pause mode for 5 minutes, it will stop automatically to protect the tape and video head.

Selecting the Input Mode (TUNER:ON only)

You can select the Input Mode in one of two ways.

- Push Δ ∇ . The display will change in the order below.

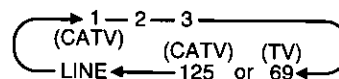

- a. Push MENU to display the menu.
- b. Push Δ ∇ \triangleleft \triangleright to select "TV," and then push MENU to display the SET UP TV screen.
- c. Push Δ ∇ to select "INPUT SELECT," and then push \triangleright repeatedly to select "TUNER" or "LINE."

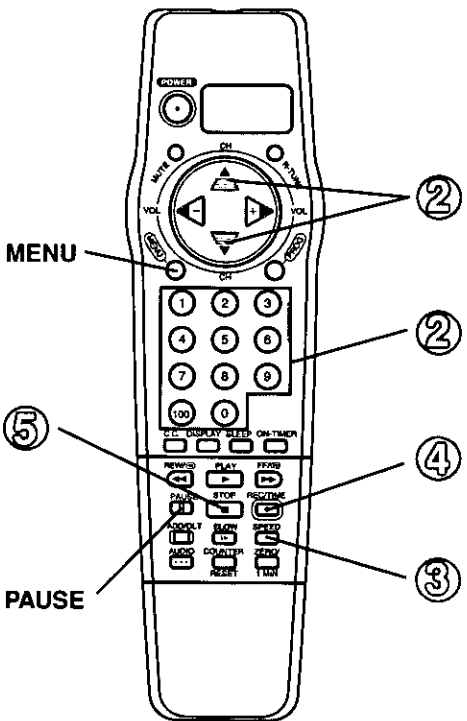
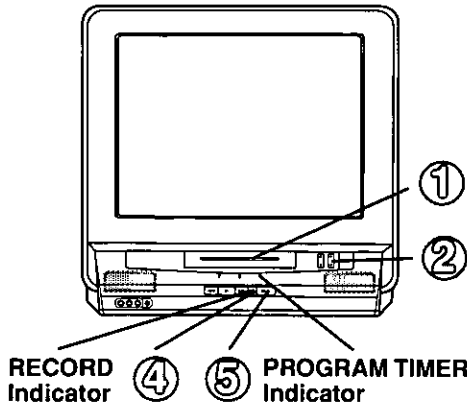

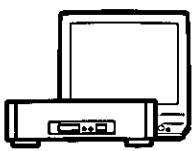

Copying Your Tapes (Dubbing)

Connections you'll need to make.

- Use this same connection for your video camera, laser disc player, video games, etc.

Recording(Editing) Combination VCR

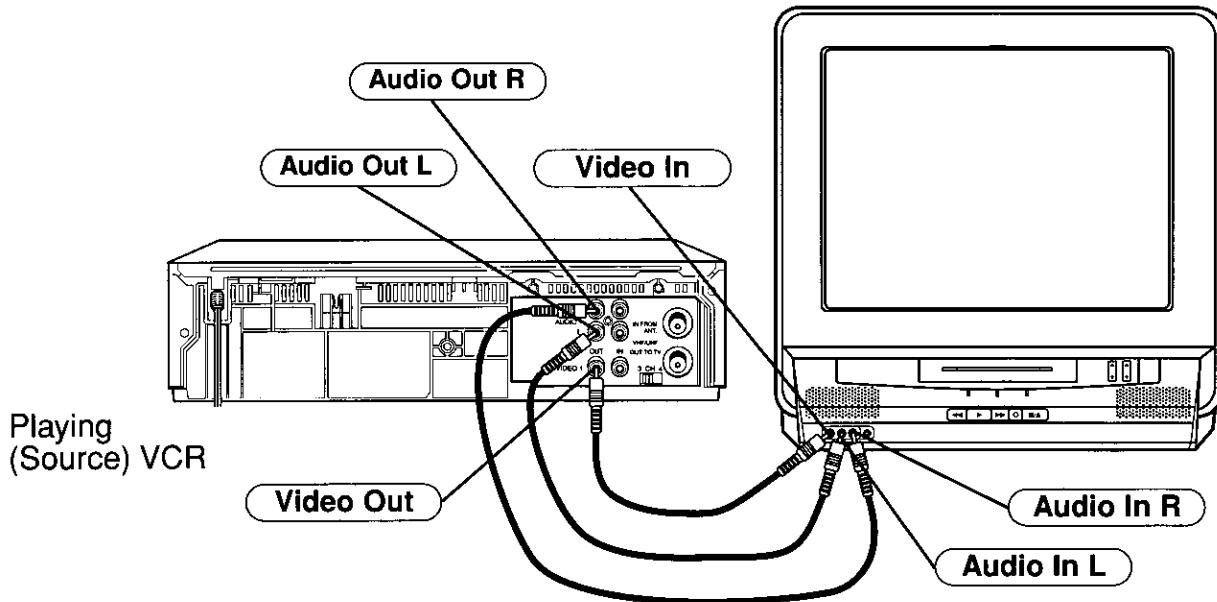

- 1 Insert a pre-recorded tape into the Playing (source) VCR.

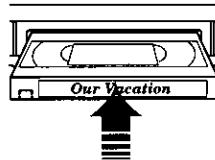

Caution:

Unauthorized exchanging and/or copying of copyrighted recordings may be copyright infringement.

- 2 Insert a blank tape with record tab into the Recording (editing) Combination VCR.

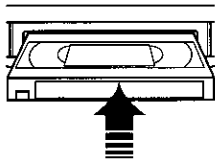

- 3 Select "LINE" as the input on the Recording Combination VCR.
 - See "Selecting the Input Mode" section on page 18.

- 4 Push **PLAY** on the playing VCR. Then, push **PAUSE** when the tape reaches the point you want to start copying.

- 5 Push **REC** on the recording Combination VCR, and then push **PAUSE** on the remote control immediately.

- 6 Push **PAUSE** on both units at the same time to begin copying.

You can edit out unwanted parts of the original recording by using the PAUSE button (on the Recording unit) while copying is in progress.

- 7 Push **STOP** on both units to stop copying.



Timer Playback

The Timer Playback feature lets you set the Combination VCR from the remote control to do unattended playback. For each program you set, the Combination VCR will turn itself on at the scheduled time and do the playback, and turn off automatically. Up to 4 programs can be placed in memory. You can choose to playback daily or weekly.

Check list before you begin.

- All connections are made (see page 5).
- Your Combination VCR is plugged in.
- The clock is set.

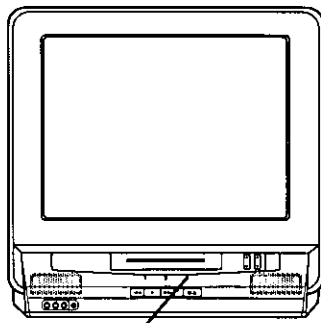

PROGRAM TIMER Indicator

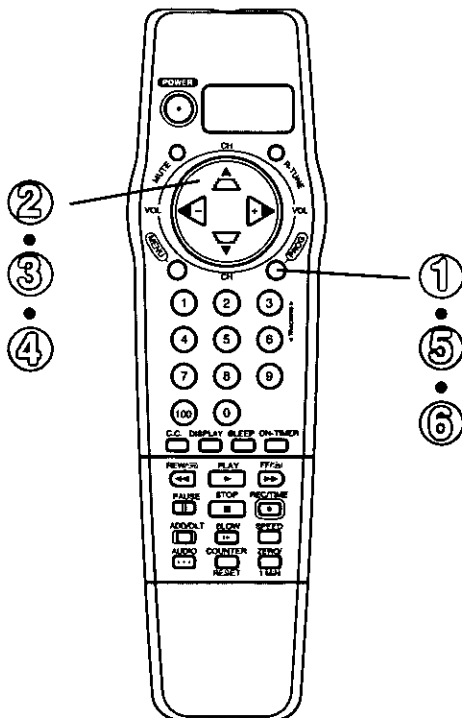

1 Push PROG to display the "SET PROGRAM" screen.

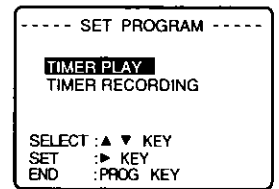

2 Push Δ ∇ to select "TIMER PLAY," and then push \blacktriangleright to display the program screen.

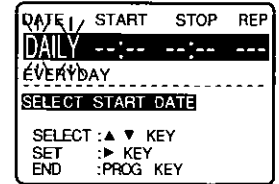

• If a program is already in memory, push Δ ∇ repeatedly, and then \blacktriangleright to select an unused program number.

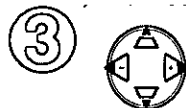

3 Push Δ ∇ and \blacktriangleright to select and set one of the following:

- DAILY(EVERYDAY) = Same time everyday
- DAILY(MON ~ FRI) = Same time MON ~ FRI
- DAILY(MON ~ SAT) = Same time MON ~ SAT
- WEEKLY = Same time once a week

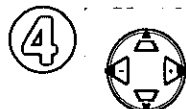
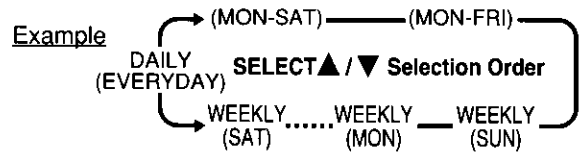

4 Push Δ ∇ and \blacktriangleleft \blacktriangleright to select and set each of the remaining items at right.

Remaining Items:

- START time
- STOP time
- REPEAT PLAY: "YES" or "NO"

To Make Corrections

Repeatedly push \blacktriangleright to move the cursor to the right, or \blacktriangleleft to move to the left to the incorrect entry and make the correction.



5 Push PROG to end the program.

- This screen appears for confirmation.

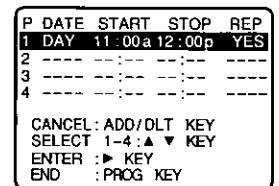

To Enter More Programs

Push Δ ∇ and \blacktriangleright to select and set a blank program number, and then repeat steps 3 and 4.



6 Push PROG twice to return to the normal screen.

- The PROGRAM TIMER indicator lights on the front panel.

Two minutes before the Timer Playback starts, "TIMER PLAY WILL START SOON" will appear on-screen.

Cancel a Timer Playback: (Playback is in progress)

Hold down STOP for a few seconds to cancel the Timer Playback.

- Any future daily or weekly playbacks will be performed as programmed.

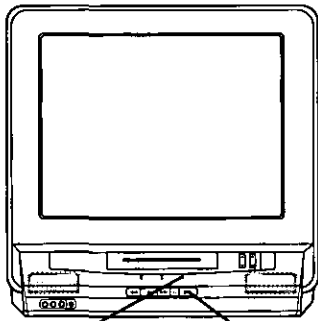

PROGRAM TIMER Indicator

STOP/EJECT

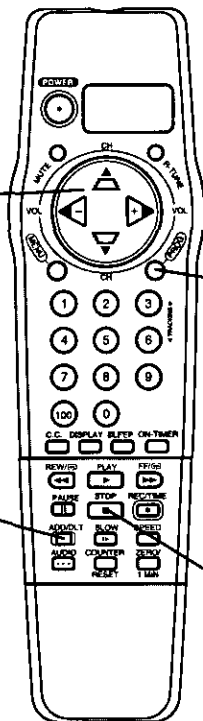

a 1
•
b 2
•
c 3

a 1
•
d 4

STOP

Replace Program Contents: (Playback is not in progress)

1 Do steps 1 and 2 on previous page. All currently set programs will be displayed on-screen.

2 Push Δ ∇ repeatedly to select the desired timer playback, and then push \triangleright to display the settings. (See page 20.)

3 Push Δ ∇ repeatedly to select, and then push \triangleright to enter replacement information.

4 Push PROG three times to exit this mode and return to the normal TV screen.

P	DATE	START	STOP	REP
1	---	---	---	---
2	SUN	10:00p	12:00p	YES
3	MO-SA	8:00p	9:00p	NO
4	DAY	9:00p	10:00p	YES

SELECT 1-4: Δ ∇ KEY
ENTER: \triangleright KEY
END: PROG KEY

DATE	START	STOP	REP
DAILY	12:00P	12:30P	YES
EVERYDAY	---	---	---

SELECT START DATE
SELECT: Δ ∇ KEY
SET: \leftarrow \rightarrow KEY
END: PROG KEY

Review or Clear Program Contents: (Playback is not in progress)

a. Do steps 1 and 2 on previous page. All currently set programs will be displayed on-screen.

b. Push Δ ∇ repeatedly to select the desired program number.

c. Push the ADD/DLT to clear the program.

d. Push PROG twice to exit this mode and return to the normal TV screen.

P	DATE	START	STOP	REP
1	DAY	11:00a	12:00p	YES
2	SUN	12:00p	12:30p	YES
3	MO-SA	8:00a	9:00a	NO
4	MO-FR	7:00p	9:30p	NO

CANCEL: ADD/DLT KEY
SELECT 1-4: Δ ∇ KEY
ENTER: \triangleright KEY
END: PROG KEY

P	DATE	START	STOP	REP
1	---	---	---	---
2	SUN	10:00p	12:00p	YES
3	MO-SA	8:00p	9:00p	NO
4	DAY	9:00p	10:00p	YES

SELECT 1-4: Δ ∇ KEY
ENTER: \triangleright KEY
END: PROG KEY

NOTES

- If "PLEASE PREPARE FOR TIMER PLAY" appears and/or the PROGRAM TIMER indicator flashes, check that a cassette is loaded and the Combination VCR is in Stop mode.
- If the start times of two programs overlap, the lower numbered program will have priority.
- If the start time for a Timer Playback comes up during a normal recording or One Touch Recording (page 18), Timer Playback will not be performed.
- If there is a power interruption of more than one minute, the playback may not be performed or continue.
- If "INCOMPLETE" appears after all items have been set, check all entries and make necessary corrections.



Timer Recording

Your Combination VCR can be set up to do a recording while you are away or otherwise occupied. Up to 4 programs can be placed in memory. You can choose to record one time, daily, or weekly.

✓ Check list before you begin.

- All connections are made (see page 5).
- Your Combination VCR is plugged in.
- The clock is set.
- The tape is long enough.
- The record tab is in place.

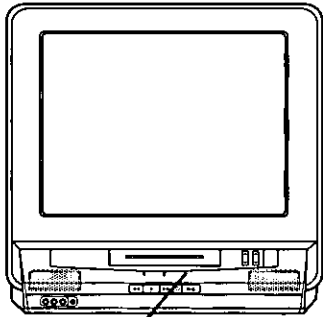

PROGRAM TIMER Indicator

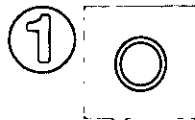
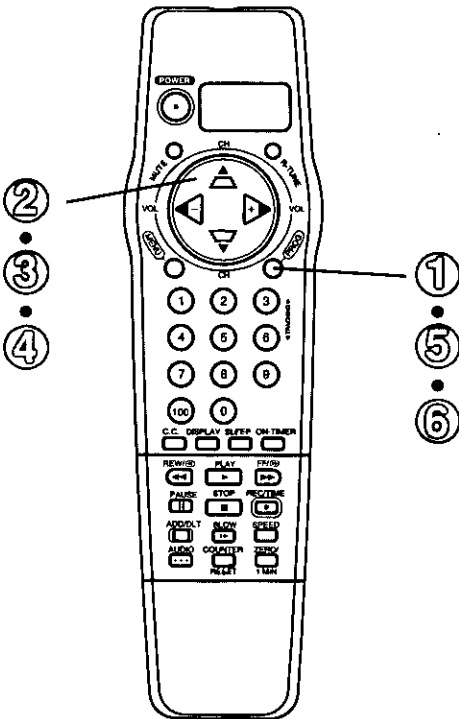

Push PROG to display the "SET PROGRAM" screen.

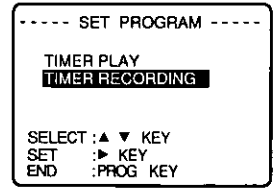

Push Δ ∇ to select "TIMER RECORDING," and then push \triangleright to display the program screen.

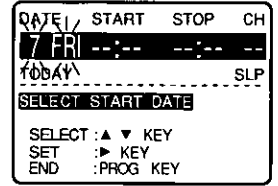

• If a program is already in memory, push Δ ∇ repeatedly, and then \triangleright to select an unused program number.

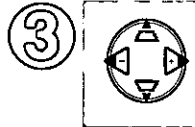

Push Δ ∇ and \triangleright to select and set one of the following:

- 1~31 = One time recording
- DAILY = Same time MON ~ FRI
- WEEKLY = Same time once a week

Example

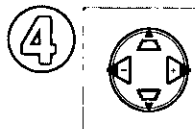
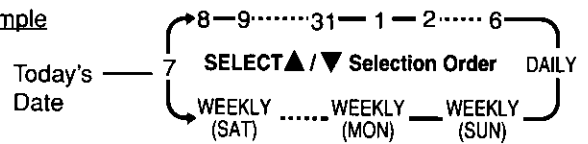

Push Δ ∇ and \triangleleft \triangleright to select and set each of the remaining items at right.

- Remaining Items:**
- START time
 - STOP time
 - CH(annel) number, or LINE for outside source recording
 - Speed (SP, LP, SLP)

To Make Corrections

Repeatedly push \triangleright to move the cursor to the right, or \triangleleft to move to the left to the incorrect entry and make the correction.



Push PROG to end the program.

- This screen appears for confirmation.

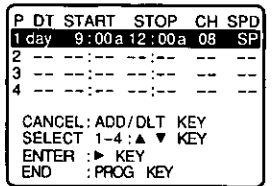

To Enter More Programs

Push Δ ∇ and \triangleright to select and set a blank program number, and then repeat steps 3 and 4.

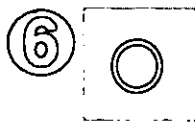

Push PROG twice to return to the normal screen.

- The PROGRAM TIMER indicator lights on the front panel.
- If you're using a cable box, make sure that it is tuned to the desired channel and the power is left on for timer recording.

Two minutes before the Timer Recording starts, "TIMER REC WILL START SOON" will appear on-screen.

Cancel a Timer Recording: (Recording is in progress)

Hold down STOP for a few seconds to cancel the Timer Recording.

- Any future daily or weekly recordings will be performed as programmed.

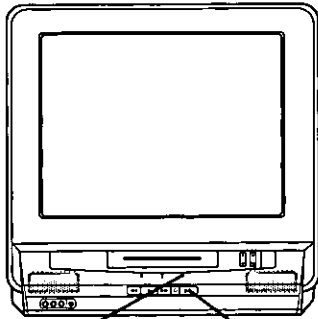

PROGRAM TIMER Indicator STOP/EJECT

Replace Program Contents: (Recording is not in progress)

1 Do steps 1 and 2 on previous page. All currently set programs will be displayed on-screen.

2 Push Δ ∇ repeatedly to select the desired timer recording, and then push \triangleright to display the settings. (See page 22.)

3 Push Δ ∇ repeatedly to select, and then push \triangleright to enter replacement information.

4 Push PROG three times to exit this mode and return to the normal TV screen.

P	DT	START	STOP	CH	SPD
1	--	--:--	--:--	--	--
2	8	10:00p	12:00p	125	SLP
3	10	8:00p	9:00p	10	SP
4	SU	9:00p	10:00p	L	SLP

SELECT 1-4: Δ ∇ KEY
 ENTER: \triangleright KEY
 END: PROG KEY

DATE	START	STOP	CH
8 SAT	10:00P	11:00P	125
			SLP

SELECT START DATE
 SELECT: Δ ∇ KEY
 SET: \leftarrow \rightarrow KEY
 END: PROG KEY

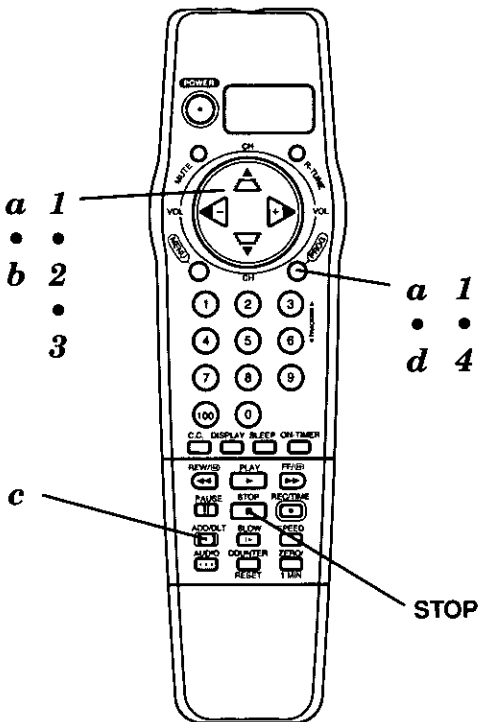

Review or Clear Program Contents: (Recording is not in progress)

a. Do steps 1 and 2 on previous page. All currently set programs will be displayed on-screen.

b. Push Δ ∇ repeatedly to select the desired program number.

c. Push the ADD/DLT to clear the program.

d. Push PROG twice to exit this mode and return to the normal TV screen.

P	DT	START	STOP	CH	SPD
1	day	9:00a	12:00a	08	SP
2	8	10:00p	12:00p	125	SLP
3	10	8:00p	9:00p	10	SP
4	SU	9:00p	10:00p	L	SLP

CANCEL: ADD/DLT KEY
 SELECT 1-4: Δ ∇ KEY
 ENTER: \triangleright KEY
 END: PROG KEY

P	DT	START	STOP	CH	SPD
1	--	--:--	--:--	--	--
2	8	10:00p	12:00p	125	SLP
3	10	8:00p	9:00p	10	SP
4	SU	9:00p	10:00p	L	SLP

SELECT 1-4: Δ ∇ KEY
 ENTER: \triangleright KEY
 END: PROG KEY



- If "PLEASE PREPARE FOR TIMER REC" appears and/or the PROGRAM TIMER indicator flashes, check that a cassette with record tab is loaded and the Combination VCR is in Stop mode.
- If the start times of two programs overlap, the lower numbered program will have priority.
- If the start time for a Timer Recording comes up during a normal recording, One Touch Recording (page 18) or Timer Playback, the Timer Recording will not be performed.
- If there is a power interruption of more than one minute, the recording may not be performed or continue.
- If "INCOMPLETE" appears after all items have been set, check all entries and make necessary corrections.

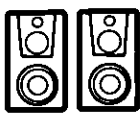

MTS Broadcast/VHS Hi-Fi Stereo System

Check list before you begin.

- All connections are made (see page 5).
- Your Combination VCR is plugged in.

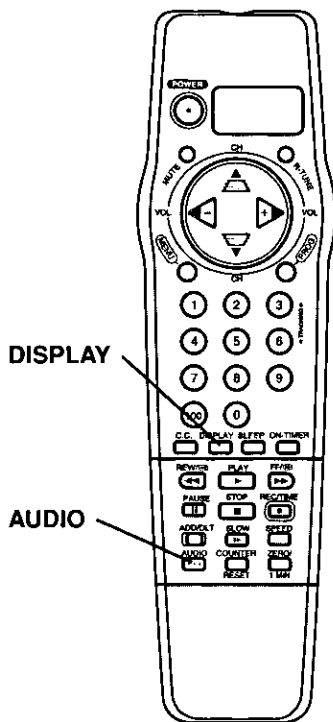

Receivable Broadcast Types

The following are possible broadcast types with their accompanying on-screen displays. The signal being received is indicated with an "Ⓜ" mark while the selected audio mode is indicated with an arrow. To change the audio mode for these broadcasts, follow the "Select Audio Mode for TV Viewing" section. (below)

 Push DISPLAY to display the broadcast signal currently being received.

MTS Stereo and SAP broadcast

Multi-channel Television Sound Stereo (main language) and Secondary Audio Program (sub language) broadcasts are being received simultaneously. Select the STEREO or SAP audio mode as desired.

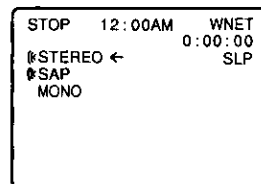

MTS Stereo broadcast

Multi-channel Television Sound Stereo broadcast is being received. Select the STEREO audio mode.

- If a stereo broadcast is weak and the display flickers, you may want to select the MONO audio mode for better results.

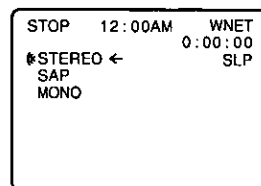

SAP broadcast

Secondary Audio Program (sub language) broadcast is being received. Select SAP audio mode for the sub language.

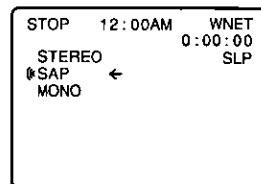

MONO broadcast

Normal monaural sound broadcast is being received.

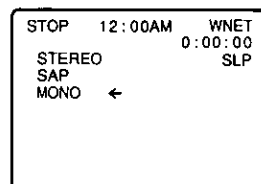

Select Audio Mode for TV Viewing

 Push AUDIO to select the desired audio mode as described above. (Arrow shows selection.)

- Each push of AUDIO will change the audio mode as shown below.

< Example >

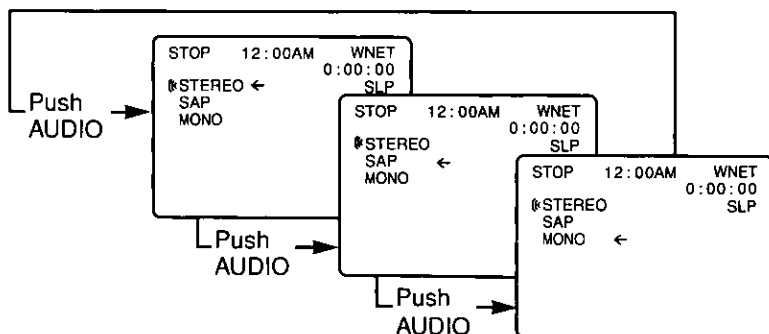

Equipped with **dbx**® -TV Noise Reduction for true MTS reproduction. **dbx**® -TV Noise Reduction is required for good stereo separation and audio fidelity. **dbx**® is a registered trademark, and is licensed by **dbx**® Technology Licensing.

With the proper audio mode setting, your Combination VCR can:

- record and playback an MTS stereo broadcast (main language) in stereo Hi-Fi. Stereo sound is recorded on the left and right audio tracks and on the video portion of a tape.
- record and playback a monaural broadcast (main language) or an SAP (Secondary Audio Program, usually in a second language) on the Hi-Fi tracks for better quality monaural sound.
- playback non-Hi-Fi tapes in monaural.

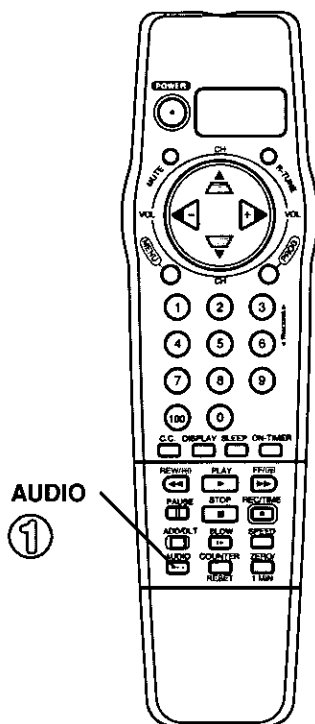

Select Audio Mode for Playback

Select the type of sound track you desire for playback.



Push AUDIO repeatedly (each push within 5 seconds) to select the desired audio mode (HIFI/NORMAL).

- Please select HIFI to listen to your stereo recordings with stereo sound or NORMAL for monaural sound.

< Example >

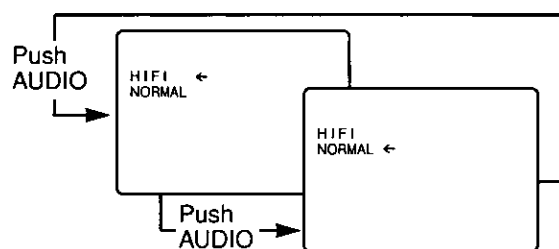

- This screen appears when you push AUDIO during playback.

② Playback the tape. See the "Playback a Tape" section on page 16.

Select Audio Mode for Recording

Select the type of broadcast and sound track you wish to record.

Ⓐ Do the operation of "Select Audio Mode for TV Viewing" section on previous page.

- Your recording is always performed according to the audio mode you selected in the "Select Audio Mode for TV Viewing" section on previous page.

Ⓑ Do a recording. See the "Record On a Tape" section on page 18.



- When purchasing or renting prerecorded tapes, remember that only those recorded in Hi-Fi stereo will play back with true stereo sound. Standard stereo tapes will play back with monaural sound.
- In order to listen to Hi-Fi stereo playback, the Combination VCR AUDIO (L/R) jacks must be connected to a stereo amp and speakers.
- There may be a difference in audio level between Hi-Fi and normal audio playback.



Unit and Cassette Information

Erase Protection (Record Tab)

Cassettes have a record tab to ensure that recordings are not accidentally erased.

To prevent accidental erasure, break off the tab with a screwdriver.



To record again, cover the hole with cellophane tape.



Maximum Record/Playback Time

Only use tapes with the **VHS** mark in this unit.

Tape Speed Setting	Type of Video Cassette		
	T60	T120	T160
SP (Standard Play)	1 Hour	2 Hours	2 Hours 40 minutes
LP (Long Play)	2 Hours	4 Hours	5 Hours 20 minutes
SLP (Super Long Play)	3 Hours	6 Hours	8 Hours

D.S.T. (Daylight Saving Time)

Spring (First Sunday in April)

When the Combination VCR is set to DST:ON, it automatically adds one hour and adjusts the clock.

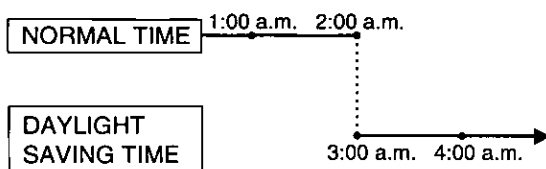

Autumn (Last Sunday in October)

When the Combination VCR is set to DST:ON, it automatically turns back one hour and adjusts the clock.

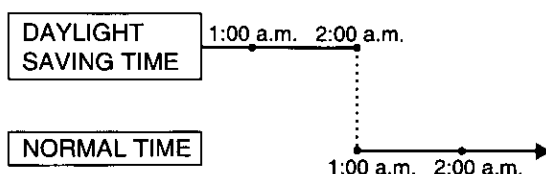

Reset all Combination VCR Memory Functions

Use when moving the Combination VCR to a new location, or if a mistake was made in the One Time Setup section.

- Make sure a tape is not inserted in the Combination VCR.
- 1) Push POWER to turn the Combination VCR on.
 - 2) Hold down both the PLAY and REW buttons on the Combination VCR for more than 5 seconds.
 - The power will shut off.
 - 3) Turn the power back on and perform the One Time Setup section on page 8.

Cleaning Care for Video Heads



Clogged Video Head Picture

or

Blue Back
(During playback of pre-recorded tape)

Blue Back Screen

Clogged Video Heads

While your Combination VCR will not normally require head cleaning, however the heads may become clogged when playing an old or damaged tape. If the image on your screen resembles the illustration on the left or the screen becomes solid blue when playing back a recorded signal on the tape, the heads probably require cleaning.

Cleaning the Heads

It is recommended that head cleaning be performed by a qualified service technician. Please contact your nearest Panasonic Service Center. An alternate solution is to obtain a head cleaning cassette. Be sure to follow the cleaning instructions carefully. Excessive use of a cleaning cassette could shorten head life. Use this cassette only when symptoms occur.

Product Specifications

Display

Picture Tube: 27 inch measured diagonal 100° deflection Picture Tube

VCR

Video Recording System: 4 rotary heads helical scanning system
Audio Track: 1 track
2 channel (Hi-Fi Audio Sound)

Tuner:

Broadcast Channels: VHF 2~13, UHF 14~69
CATV Channels: Midband A through I (14~22)
Superband J through W (23~36)
Hyperband AA~EEE (37~64)
Lowband A-5~A-1 (95~99)
Special CATV channel 5A (01)
Ultraband 65~94, 100~125

General

Power Source: 120V AC, 60 Hz
Power Consumption: Approx. 157 watts (Power on)
Approx. 7 watts (Power off)
Television System: EIA Standard NTSC color
Speaker: 2 pieces
Operating Temperature: 41°F~104°F (5°C~40°C)
Operating Humidity: 10%~75%
Weight: 85.9 lbs. (39 Kg)
Dimensions: 27-1/16" (W) X 27-15/16" (H) X 21-5/16" (D)
688 (W) X 659 (H) X 542 (D) mm

Note: Designs and specifications are subject to change without notice.



Before Requesting Service

Check the following points once again if you are having trouble with your Combination VCR.

Power	Correction
No power...	<ul style="list-style-type: none"> • Completely insert the Power Plug into an AC wall outlet. • Set the POWER button to ON.
Monitor	Correction
No picture or sound...	<ul style="list-style-type: none"> • Make sure your antenna or cable system is connected to the Combination VCR. (P. 5) • Check that the power plug is completely plugged into an AC outlet. • Check that the POWER button is set to on.
Poor picture with normal sound...	<ul style="list-style-type: none"> • Adjust the BRIGHT, SHARPNESS, and PICTURE controls in the SET UP TV menu. (P. 13)
Poor sound with normal picture...	<ul style="list-style-type: none"> • Adjust the VOLUME control. (P. 12)
Poor TV reception...	<ul style="list-style-type: none"> • Adjust the SHARPNESS and PICTURE controls in the SET UP TV menu. (P. 13)
No color or poor color...	<ul style="list-style-type: none"> • Adjust the TINT and COLOR controls in the SET UP TV menu. (P. 13)
Ghost (multiple) images...	<ul style="list-style-type: none"> • Install a directional antenna.
TV programs cannot be watched...	<ul style="list-style-type: none"> • Make sure that the channel being received is in the Combination VCR's memory. (P. 9)
VCR	Correction
TV program cannot be recorded...	<ul style="list-style-type: none"> • Make sure your antenna or cable system is connected to the Combination VCR. (P. 5) • Make sure that the record tab is intact on the cassette. (P. 26)
Timer playback/recording cannot be performed...	<ul style="list-style-type: none"> • Set the playback/recording Start/Stop time correctly. (P. 20-23) • Timer playback/recording may not be performed or continued if a power interruption of more than 1 minute occurs before or during a Timer Playback/Recording, even if power resumes thereafter.
No playback picture, or the playback picture is noisy or contains streaks...	<ul style="list-style-type: none"> • Adjust the TRACKING control in either direction. (P. 16)
Remote Control	Correction
Combination VCR cannot be remote controlled...	<ul style="list-style-type: none"> • Aim the Remote Control directly at the remote sensor on the Combination VCR. (P. 7) • Avoid all obstacles which may interfere with the signal path. • Inspect the remote batteries for possible replacement. (P. 4) • Exposing the Combination VCR remote sensor to direct fluorescent or outdoor light may cause signal interference.
Miscellaneous	Correction
Video cassette cannot be inserted...	<ul style="list-style-type: none"> • Insert cassette with window side up and the record tab facing you.
Video cassette cannot be removed...	<ul style="list-style-type: none"> • Check that the power plug is completely plugged into an AC outlet.
Eject does not function or insertion cannot be done...	<ul style="list-style-type: none"> • Turn the POWER off and then on, and try ejecting or inserting the tape again.
Video cassette ejects when a recording is started, or the power is turned off for timer recording...	<ul style="list-style-type: none"> • Make sure the record tab is intact on the cassette. (P. 26)
In stop mode, the VCR motor (CYLINDER) continues to rotate...	<ul style="list-style-type: none"> • To enable the quick play mechanism, the VCR cylinder will rotate for about 5 minutes. This reduces response time from Stop to Play mode from Play to Rewind Search mode.

Panasonic

Broadcast & Digital Systems Company

Panasonic Broadcast & Television Systems Company

Division of Matsushita Electric Corporation of America

Executive Office:

One Panasonic Way, Secaucus, NJ 07094 (201) 348-7000

Eastern Zone:

One Panasonic Way, Secaucus, NJ 07094 (201) 348-7620

Central Zone:

1707 No. Randall Road, Elgin, IL 60128 (847) 468-5200

Southern Zone:

1225 Northbrook Pkwy, Suwanee, GA 80174 (770) 338-6841

Western Zone:

6550 Katella Ave., Cypress, CA 90630 (714) 373-7275

Government Marketing Department: 52 West Gude Drive, Rockville, MD 20850 (301) 738-3840

Matsushita Electric Corporation of America

Corporate Sales Group, Hawaii Region

99-859 Iwaiwa ST., Alea, HI 96701-3267 (808) 488-7779

Panasonic Canada Inc.

5770 Ambler Drive, Mississauga, Ontario L4W 2T3 (905) 624-5010

Panasonic Sales Company

Division of Matsushita Electric of Puerto Rico, Inc.

San Gabriel Industrial Park, 65th Infantry Ave., K.M. 9.5, Carolina, PR 00630 (809) 750-4300